

**MC<sup>2</sup>**  
**AUDIO**

**δ Series**

**Processing Network Power Amplifiers**

**DELTA 80 DSP/100 DSP**  
**Operating Instructions**

**MC<sup>2</sup>**  
**AUDIO**

[www.mc2-audio.co.uk](http://www.mc2-audio.co.uk)  
Tel. +44 (0)1404 44633 Fax. +44(0)1404 44660  
MC<sup>2</sup> AUDIO | Units 6-8 Kingsgate | Heathpark Ind.Est.  
Honiton | Devon | England | EX14 1YG



## CONTENTS

DECLARATION OF CONFORMITY .....	5
THANKS .....	6
INTRODUCTION .....	6
IMPORTANT SAFETY INSTRUCTIONS .....	7
INSTRUCTIONS DE SECURITE IMPORTANTES .....	8
Installing Your Amplifier: Electrical Considerations .....	9
Installing Your Amplifier: Mechanical Considerations .....	10
Installing Your Amplifier: RF Emissions .....	10
About Your Amplifier: Dynamic Amplifier Performance Measurements .....	11
Connecting To Your Amplifier: Line Inputs and Outputs .....	12
Connecting To Your Amplifier: Speaker Outputs .....	13
Connecting To Your Amplifier: Bridged (Mono) Operation .....	14
Operating Your Amplifier: Front Panel Controls and Indicators .....	15
Operating Your Amplifier: Rear Panel Sockets and Switches .....	17
Operating Your Amplifier: Initial Set-up and Switching On .....	18
Switching On .....	18
Inside Your Amplifier: DSP Layout, Configurations and Routing .....	19
Source Choices and Selection .....	20
Input Processing Channels .....	21
Mix Matrix Section .....	21
Power Amplifier and Auxiliary Output Processing Channels .....	22
Independent Network Audio Outputs .....	23
Operating Your Amplifier: Directly Editing Audio Parameters .....	24
Overview .....	24
Input Gain .....	25
Input Delay .....	25
Input Parametric EQ Bands 1 through 8 .....	26
Output Gain .....	27
Output Polarity .....	27
Output Delay .....	27
Output High Pass Filter .....	28
Output Low Pass Filter .....	28
Output Parametric EQ Bands 1 through 9 .....	29
Output Limiters: Program Limiter .....	30
Output Limiters: Peak Limiter .....	30
Output Matrix Gains .....	31

Operating Your Amplifier: Advanced Editing Features .....	32
Overview .....	32
Selecting Available Sources (Analogue, AES, Network Audio) .....	32
Switching from Analogue to AES Sources.....	33
Choosing Sources to Route to Input Processing Channels.....	34
Changing Network Output Source .....	35
Changing Crossover Configuration .....	37
Using Free Assign Mode .....	38
Bridged Mode for Output Pairs.....	39
Resetting Audio Parameters .....	41
Ganging Channels for Editing .....	41
 Operating Your Amplifier: Storing and Recalling Settings.....	 43
Memory Overview.....	43
Storing a Memory.....	44
Recalling a Memory... ..	45
 Operating Your Amplifier: System Adjustments .....	 46
Overview.....	46
 Operating Your Amplifier: Remote Control .....	 47
Overview.....	47
Remote Control Software Choices.....	47
Configuration of the Remote Interface .....	48
Wireless Connection with DeltaDirect iPad App .....	53
 Operating Your Amplifier: Resetting Back to Defaults and Clearing Security	54
Default Settings .....	54
Entering Start-up Control Codes .....	54
Clearing Security – Forgotten Unlock Code .....	55
 Looking After Your Amplifier: Maintenance .....	 56
Looking After Your Amplifier: Warranty.....	56
 Performance Of Your Amplifier: Specifications .....	 57
 Appendix I: Limiters and How to Set Them Correctly .....	 60
Program Limiter .....	60
Peak Limiter.....	61
Setting Accurate Limiter Thresholds – Program Limiter .....	64
Amplifier Outputs’ Program Limiter Lookup Table .....	65
Auxiliary Outputs’ Program Limiter Lookup Table .....	66
Setting Accurate Limiter Thresholds – Peak Limiter .....	67
Setting Appropriate Attack and Release Times .....	67
 Appendix II: Upgrading Firmware and Loading Presets .....	 69
Amplifier Communications Set-up .....	69
Download the Files .....	69
Connect To The Amplifier .....	70
Choose What To Load.....	70
Start The Update! .....	71
What If It All Goes Wrong.....	71



DECLARATION OF CONFORMITY

We, the manufacturer:

**MC² Audio,  
Units 6-8 Kingsgate  
Heathpark Industrial Estate  
Honiton, Devon  
England  
EX14 1YG**

acknowledge our responsibility that the following products:

**Kind of equipment: Audio amplifier**  
**Commodity Code: 8518408099**  
**Type Designation: Delta80DSP, Delta100DSP**  
**Delta40S, Delta80S, Delta100S, Delta120S**  
**T500, T1000, T1500, T2000, T3500, T4-250**  
**Ti500, Ti1000, Ti1500, Ti2000, Ti3500, Ti4-250**  
**E15, E25, E45, E60, E90, E100, E475**  
**S800, S1400, D80DSP**  
**and all OEM variants of these models**

are manufactured:

in accordance with EMC Directive 2004/108/EC,  
in compliance with the following norm(s) or document(s):  
**Technical Regulations: EN55103-1:1996, EN55103-2:1996**

and

in accordance with the Low Voltage Directive 2006/95/EC,  
in compliance with the following norm(s) or document(s):  
**Technical Regulations: EN/IEC60065:2002 7<sup>th</sup> Edition**

Signed:

Name: Alex Cooper  
Position: Research and Development Manager  
Date: January 2017



## THANKS

Thank you for choosing a Delta Series amplifier for your application. Please spend a little time reading through this manual, so that you obtain the best possible performance from the unit and become familiar with its operating requirements.

All MC<sup>2</sup> products are carefully designed and engineered for cutting-edge performance and world-class reliability. If you would like further information about this or any other MC<sup>2</sup> product, please contact us.

We wish you many years of service from this amplifier and look forward to hearing from you in the near future.



## INTRODUCTION

The Delta Series has been designed to combine incredible audio power and performance with ultra-flexible connectivity for both remote control and audio. Exemplary audio processing is assured through the use of XTA's DSP platform, and power amplifier capabilities are taken care of with high efficiency output stages and a generous power supply.

Accepting analogue, AES3 digital and optional Dante networked audio, the Delta 80 DSP and Delta 100 DSP can connect to any source and make it available over the network, as well as processing four additional channels with local analogue outputs to connect to non-DSP Delta amplifiers. These auxiliary processed outputs can also be fed onto the network, and used by non-DSP Delta amplifiers that have Dante cards fitted, or by any other Dante enabled device.

Connectivity for remote control is covered by USB, Ethernet and RS485, with relay of either USB or Ethernet control via RS485 to work with legacy products. Configuration of the amplifier's processing is through the industry standard AudioCore application, with tuning and monitoring of a network of Delta DSP amplifiers handled wirelessly by the dedicated DeltaDirect iPad app.

With a range of power levels available in the Delta Series, the non-DSP amplifiers can be networked to a single Delta DSP model, creating a powerful, efficient system that's easy to expand and adapt for use in live, install and everything in between.

#powermeetsprocessing

## IMPORTANT SAFETY INSTRUCTIONS

CAUTION: RISK OF ELECTRIC SHOCK.  
DO NOT OPEN

The lightning flash with arrowhead symbol within an equilateral triangle is intended to alert the user to the presence of uninsulated "dangerous voltage" within the product's enclosure that may be of sufficient magnitude to constitute a risk of electric shock to persons.



The exclamation mark within an equilateral triangle is intended to alert the user of important operating and maintenance (servicing) instructions in the literature accompanying the appliance.

**WARNING:** Apparatus with CLASS I construction shall be connected to a MAINS socket outlet with a protective earthing connection.

**WARNING:** To prevent injury, this apparatus must be securely attached to the rack in accordance with the installation instructions.

1. Read these instructions.
2. Keep these instructions.
3. Heed all warnings.
4. Follow all instructions.
5. Do not use this apparatus near water.
6. Clean only with a dry cloth.
7. Do not block any ventilation openings, install in accordance with the manufacturer's instructions.
8. Do not install near any heat sources, such as radiators, heat registers, stoves or other apparatus (including amplifiers) that produce heat.
9. Do not defeat the safety purpose of the polarized or grounding-type plug. A polarized plug has two blades with one wider than the other. A grounding-type plug has two blades and a third grounding prong. The wide blade or the third prong are provided for your safety. If the provided plug does not fit into your outlet, consult an electrician for replacement of the obsolete outlet.
10. Protect the power cord from being walked on or pinched particularly at plugs, convenience receptacles and the point where they exit from the apparatus.
11. Only use attachments/accessories specified by the manufacturer.



12. Use only with the cart, tripod, bracket or table specified by the manufacturer, or sold with the apparatus. When a cart is used, use caution when moving the cart/apparatus combination to avoid injury from a tip over.

13. Unplug this apparatus during lightning storms or when unused for a long period of time.

14. Refer all servicing to qualified service personnel. Servicing is required when the apparatus has been damaged in any way, such as if the power-supply cord or plug is damaged, liquid has been spilled or objects have fallen into the apparatus, the apparatus has been exposed to rain or moisture, does not operate normally, or has been dropped. This equipment contains a non-user replaceable lithium battery for memory retention. Should this battery fail and user settings be lost, do not attempt to replace the battery yourself but return the equipment to an authorised service centre.

15. Do not expose this equipment to dripping or splashing and ensure that no objects filled with liquids, such as vases, are placed on the equipment.

16. To completely disconnect this equipment from the AC mains, disconnect the power cord from the mains circuit breaker.

17. This unit is fitted with a 3-wire power cord. For safety reasons, THE EARTH LEAD SHOULD NOT BE DISCONNECTED IN ANY CIRCUMSTANCE.



18. Correct disposal of this product: This symbol indicates that this product must not be disposed of with household waste, according to the WEEE Directive (2012/19/EU) and your national law. This product should be taken to a collection center licensed for the recycling of waste electrical and electronic equipment (EEE). The mishandling of this type of waste could have a possible negative impact on the environment and human health due to potentially hazardous substances that are generally associated with EEE. At the same time, your cooperation in the correct disposal of this product will contribute to the efficient use of natural resources. For more information about where you can take your waste equipment for recycling, please contact your local city office, or your household waste collection service.

## INSTRUCTIONS DE SECURITE IMPORTANTES

**ATTENTION: RISQUE DE CHOC ELECTRIQUE.  
NE PAS OUVRIR**

Le symbole représentant un éclair fêché dans un triangle équilatéral a pour but d'alerter l'utilisateur de la présence d'une "tension dangereuse" non isolée à l'intérieur du boîtier, pouvant être d'une force suffisante pour constituer un risque d'électrocution.



Le point d'exclamation dans un triangle équilatéral a pour but d'alerter l'utilisateur de la présence d'instructions importantes concernant le fonctionnement et la maintenance, dans la documentation qui accompagne l'appareil.

**ATTENTION:** Appareils de construction de CLASSE I doit être raccordé au réseau électrique via une prise de courant reliée à la terre.

**ATTENTION:** Pour éviter toute blessure, cet appareil doit être solidement fixé à la torture, conformément aux instructions d'installation.

1. Lisez ces consignes.
2. Conservez ces consignes.
3. Respectez tous les avertissements.
4. Respectez toutes les consignes d'utilisation.
5. N'utilisez jamais l'appareil à proximité d'un liquide.
6. Nettoyez l'appareil avec un chiffon sec.
7. Veillez à ne pas empêcher la bonne ventilation de l'appareil via ses ouïes de ventilation. Respectez les consignes du fabricant concernant l'installation de l'appareil.
8. Ne placez pas l'appareil à proximité d'une source de chaleur telle qu'un chauffage, une cuisinière ou tout appareil dégageant de la chaleur (y compris un ampli de puissance).
9. Ne supprimez jamais la sécurité des prises bipolaires ou des prises terre. Les prises bipolaires possèdent deux contacts de largeur différente. Le plus large est le contact de sécurité. Les prises terre possèdent deux contacts plus une mise à la terre servant de sécurité. Si la prise du bloc d'alimentation ou du cordon d'alimentation fourni ne correspond pas à celles de votre installation électrique, faites appel à un électricien pour effectuer le changement de prise.
10. Installez le cordon d'alimentation de telle façon que personne ne puisse marcher dessus et qu'il soit protégé d'arêtes coupantes. Assurez-vous que le cordon d'alimentation est suffisamment protégé, notamment au niveau de sa prise électrique et de l'endroit où il est relié à l'appareil; cela est également valable pour une éventuelle rallonge électrique.
11. Utilisez exclusivement des accessoires et des appareils supplémentaires recommandés par le fabricant.
12. Utilisez exclusivement des chariots, des diables, des présentoirs, des pieds et des surfaces de travail recommandés par le fabricant ou livrés avec le produit. Déplacez précautionneusement tout chariot ou diable chargé pour éviter d'éventuelles blessures en cas de chute.
13. Débranchez l'appareil de la tension secteur en cas d'orage ou si l'appareil reste inutilisé pendant une longue période de temps.
14. Les travaux d'entretien de l'appareil doivent être effectués uniquement par du personnel qualifié. Aucun entretien n'est nécessaire sauf si l'appareil est endommagé de quelque façon que ce soit (dommages sur le cordon d'alimentation ou la prise par exemple), si un liquide ou un objet a pénétré à l'intérieur du châssis, si l'appareil a été exposé à la pluie ou à l'humidité, s'il ne fonctionne pas correctement ou à la suite d'une chute. Pour la mémorisation des paramètres, cet appareil contient une pile au lithium non remplaçable par l'utilisateur. En cas de défaillance de la pile et perte des réglages, n'essayez pas de remplacer la pile par vous-même. Retournez votre appareil vers une station technique habilitée.
15. N'exposez pas cet équipement au fait de tomber goutte à goutte ou au fait d'éclabousser et garantisiez qu'aucun objet rempli des liquides, comme les vases, n'est placé sur l'équipement.
16. Pour complètement débrancher cet équipement de la conduite principale de courant alternatif, débranchez la corde de pouvoir du disjoncteur de conduite principale.
17. Cette unité est correspondue avec une corde de pouvoir de 3 fils. Pour les raisons de sécurité, L'AVANCE DE TERRE NE DEVRAIT ÊTRE DÉBRANCHÉE DANS AUCUNE CIRCONSTANCE.
18. Mise au rebut appropriée de ce produit: Ce symbole indique qu'en accord avec la directive DEEE (2012/19/EU) et les lois en vigueur dans votre pays, ce produit ne doit pas être jeté avec les déchets ménagers. Ce produit doit être déposé dans un point de collecte agréé pour le recyclage des déchets d'équipements électriques et électroniques (EEE). Une mauvaise manipulation de ce type de déchets pourrait avoir un impact négatif sur l'environnement et la santé à cause des substances potentiellement dangereuses généralement associées à ces équipements. En même temps, votre coopération dans la mise au rebut de ce produit contribuera à l'utilisation efficace des ressources naturelles. Pour plus d'informations sur l'endroit où vous pouvez déposer vos déchets d'équipements pour le recyclage, veuillez contacter votre mairie ou votre centre local de collecte des déchets.





## Installing Your Amplifier: Electrical Considerations

The amplifier has been manufactured to comply with your local power supply requirements, but before connecting the unit to the supply, ensure that the voltage (printed on the rear panel) is correct.

The amplifier is fitted with either a 100/120V or 220/240V tapped transformer according to customer requirements.

Make sure power outlets conform to the power requirements listed on the back of the unit. Damage caused by connecting to improper AC voltage is not covered by the warranty.

### **SAFETY WARNING**

Where a MAINS plug or appliance coupler is used as the disconnect device, it should remain readily operable.

Where the amplifier is mounted in a rack and permanently connected to the mains, then the rack should be installed with a readily accessible connector or an ALL POLE circuit breaker with 3mm breaking distances.

This unit is fitted with a 3-wire power cord.

For safety reasons,

**THE EARTH LEAD SHOULD NOT BE DISCONNECTED IN ANY CIRCUMSTANCE.**

If ground loops are encountered consult the section on connecting your amplifier on page 12.

The wiring colours are:

230V AREAS: EARTH = GREEN AND YELLOW  
NEUTRAL = BLUE  
LIVE = BROWN

DO NOT USE THE UNIT IF THE ELECTRICAL POWER CORD IS FRAYED OR BROKEN. The power supply cords should be routed so that they are not likely to be walked on or pinched by items placed upon or against them, paying particular attention to cords and plugs and the point where they exit from the appliance.

ALWAYS OPERATE THE UNIT WITH THE AC GROUND WIRE CONNECTED TO THE ELECTRICAL SYSTEM GROUND. Precautions should be taken so that the means of grounding of a piece of equipment is not defeated.

DO NOT REMOVE THE LID. Removing the lid will expose you to potentially dangerous voltages. There are no user serviceable parts inside.

ESD strikes to the unit's front panel that are in excess of 4000 volts may cause disturbance to the status LEDs on the unit. This will not affect audio performance and will be corrected on the next power up cycle.

## Installing Your Amplifier: Mechanical Considerations

To ensure that this equipment performs to specification, it should be mounted in a suitable rack or enclosure as described below. Like all high power amplifiers, it should be kept away from other equipment which is sensitive to magnetic fields. Also, this amplifier may suffer a substantial reduction in performance if it is subjected to, or mounted close to equipment which radiates high RF fields.

**Warning:** To prevent injury, this apparatus must be securely attached to the rack in accordance with the installation instructions

When mounting the amplifier in a rack or enclosure:

Be aware that...

THE FRONT PANEL IS NOT CAPABLE OF SUPPORTING THE UNIT ON ITS OWN.

Make sure that the rear of the unit is adequately supported. The brackets which are supplied fit standard 19 inch (483mm) rack mounting systems.

ENSURE THERE IS ADEQUATE VENTILATION.

The cooling fans suck cool air in through the front and blow hot air out at the rear of the unit through the ventilating grills. The front and rear of the amplifier should have free exposure to the air (i.e. in a rack leave the front & rear doors off), with 2cm air gap at the sides.

IF AIR IS NOT ALLOWED TO ESCAPE FROM THE REAR, OVER-HEATING WILL OCCUR.

Take care when mounting other equipment in the same rack.

Make sure that the rack unit has a separate earth connection (technical earth).

Please also see the notes regarding maintenance on page 56.

## Installing Your Amplifier: RF Emissions

The high frequency resonant converters in the Delta Series amplifiers have been designed to have very low radio frequency (RF) emissions; however even these low level emissions can cause interference with other equipment.

In order for this to be minimised, the amplifier should be mounted in a metal rack enclosure, which should have a separate (technical) Earth. Alternatively, a separate earth should be attached to the amplifier at the rear rack mounting bracket.

## About Your Amplifier: Dynamic Amplifier Performance Measurements

The Delta 80 DSP and Delta 100 DSP are the very latest examples of a 'dynamic amplifier'. This new 'breed' of power amplifiers provide very high peak power levels in a much smaller, and lighter, package than previously possible with conventional amplifiers.

They are designed specifically for today's high power audio installations, which use multiple speakers with electronic crossovers or speaker controllers. These systems can handle very high transient signals that far exceed their RMS power rating. The Delta Series amplifiers have been designed to match this requirement and can deliver huge levels of power for short durations.

In order to protect themselves and the loudspeakers that they are driving, continuous signals such as sine waves, are automatically detected and reduced (ramped down) to a safe level.

When trying to **measure the power output** however, continuous signals will give totally incorrect results. A dynamic signal, such as a tone burst, should be used and the levels measured by monitoring the waveform on an oscilloscope. The power envelope can then be accurately measured.

Our power output figures are measured using signals with known Crest Factors and are quoted at the rear of this manual on page 57 and on our website.

Please refer to the technical area of our website for further information – here you can download a set of Crest Factor tailored audio samples to allow you to compare our specifications with any other amplifier.

## Connecting To Your Amplifier: Line Inputs and Outputs

The inputs are made via 3-pin XLR connectors, which are electronically balanced and should be connected via a high grade twin core screened cable, as follows:

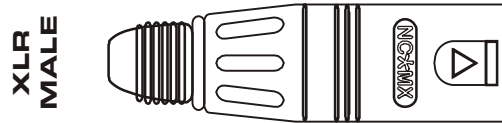

PIN1: Screen (see note below)  
 PIN2: Hot (signal +)  
 PIN3: Cold (signal -)

The amplifier is designed to operate with fully balanced equipment and ground loops or loss of performance may be experienced if connected to unbalanced sources. If it is unavoidable however, the following wiring should be used. The cable should still be twin core plus screen.

PIN1: Screen - connected to the chassis of the unbalanced equipment - or left disconnected at the unbalanced end.  
 PIN2: Hot (signal +)  
 PIN3: Cold (ground 0V)

NOTE: This amplifier is wired to the latest industry recommendations. PIN1 is connected directly to the chassis/mains earth. If ground loops (mains hum) are encountered remove the screen connection from the other end of the cable and leave it open circuit. If problems persist, consult your dealer/supplier.

**DO NOT TAMPER WITH OR ALTER ANY GROUND (EARTH) CONNECTIONS INSIDE THE AMPLIFIER.**

For bridged operation input should be made to channel A (or C) only and the channels set for bridged mode for the appropriate pair of channels. Please see page 39 for details of how to do this.

Outputs are also made via 3-pin XLR connectors wired as follows:

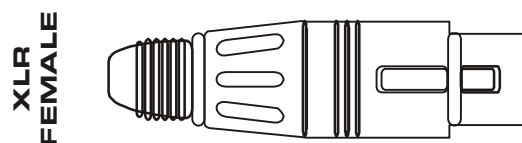

PIN1: Screen (see note above)  
 PIN2: Hot (signal +)  
 PIN3: Cold (signal -)

Note that the rear panel outputs are electronically balanced and so are not galvanically (electrically) isolated. Front panel outputs are transformer balanced and so are isolated.

## Connecting To Your Amplifier: Speaker Outputs

The speaker outputs are via Neutrik Speakon connectors. 2 pole (NL2FC) or 4 pole (NL4FC) connectors can be used.

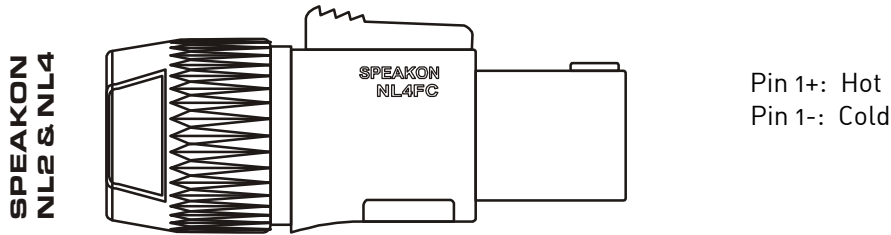

Additionally, Channel 1 Speakon connector carries Channel B2 output on Pins +2 & -2 to allow easy bi-amping or bridged operation using a single NL4 connector. Similarly, Channel 3's Speakon connector also carries Channel 4 output.

### Output Connector 1

Pin 2+: Hot Ch. 2  
Pin 2-: Cold Ch. 2

### Output Connector 3

Pin 2+: Hot Ch. 4  
Pin 2-: Cold Ch. 4

For bi-amped operation, connect as above.

**There must be no shared connections between channels.**

**Negative output terminals must not be joined together as they are not both at ground potential. Connecting them together will damage the amplifier and void the warranty!**

As the currents involved are very high, and to ensure best performance, the speaker cables should be kept as short as possible and conform to the following minimum requirements:

Delta 80 DSP, 11A into 4 Ohm speaker loads  
Delta 100 DSP, 20A into 4 Ohm speaker loads

When operating the amplifier into loads of less than 4 Ohms, be aware that the current capacity of the speaker cables will need to be increased above the values quoted here.

Do not connect the inputs/outputs to any other voltage source such as a battery, mains source or power supply, regardless of whether the amplifier is turned on or off.

Do not run the output of any amplifier channel back into another channel's input and do not parallel or series-connect an amplifier output with any other amplifier output.

## Connecting To Your Amplifier: Bridged (Mono) Operation

Pairs of channels may be independently bridged – channel pair 1+2, and/or channel pair 3+4.

The method is the same for both channel pairs:

Select the required bridged mode through the front panel MENU system (see page 39 for more information).

Use Channel 1 or 3's Output Speakon connector and connect as follows:

Pin 2+: Hot

Pin 1-: Cold

When operating in bridged mode, the minimum impedances are doubled.

**The minimum load in bridged mode is 4 ohms.**

## Operating Your Amplifier: Front Panel Controls and Indicators

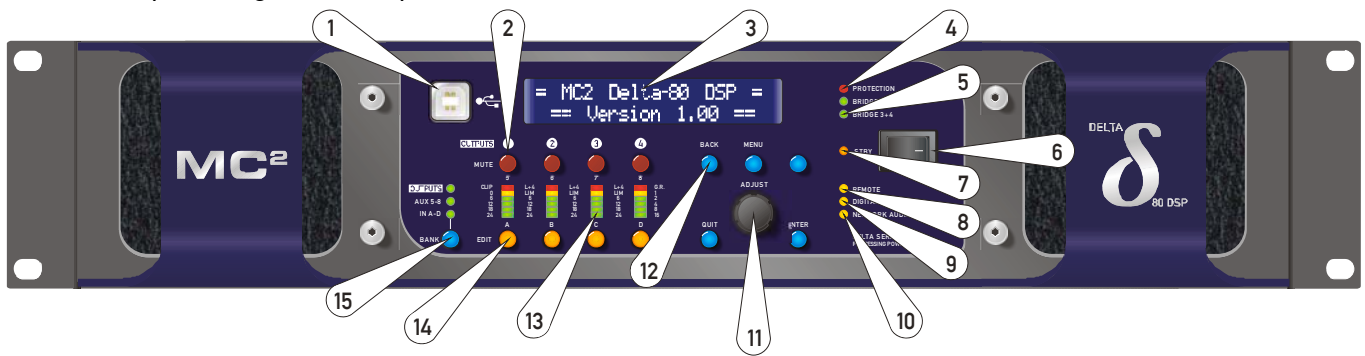

1: USB Type "B": Connect to a computer for remote control – a driver will be required. Please see the section on remote control starting on page 46.

2: MUTE keys: This will mute the respective input or output channel according to the current setting of the bank control selection (#14).

3: 2 x 24 LCD: By default this will display preset names and is used to show all parameter information. The LCD contrast and backlight brightness can be adjusted in the System Sub-Menu – see page 43 for details. If the LCD backlight is flashing, it is being remotely identified by software.

4: PROTECTION LED: If a condition exists, either internally or externally, that could cause damage to either the amplifier or the speakers, the protection circuit will disengage the outputs and this LED will illuminate/flash.

Typical conditions that could cause the protection to be triggered include very high frequency or subsonic input signals, DC in the inputs, short-circuited outputs, or internal high temperatures.

The protection circuit can affect all channels or a 'channel pair' depending on the type of fault. This is indicated by the combination of Protection LED illuminating and a corresponding message on the LCD. In this way, it is possible for two channels (a channel pair) to remain functioning even though a fault has caused the other channel pair to mute. A channel pair would be 1+2 or 3+4.

Temperature related faults will reset automatically if the unit has cooled sufficiently. Output short circuits will require manual reset after clearing the fault (switching off at the mains switch and then on again after a few seconds). Short circuits on either channel of a channel pair will only affect that channel pair.

5: BRIDGE pair LEDs: The channel pair LED will illuminate if these channels have been switched into bridged (mono) mode. See page 12 for details of how to connect your speaker to a bridged channel pair, and page 39 for how to enable bridge mode.

6: Power Switch: This double pole switch turns the amplifier fully off and isolates it from the mains supply.

7: STBY LED: The power amplifiers in the Delta 80 can be powered down leaving just the DSP active. Apart from the obvious power savings to be made, there may be circumstances when only the DSP is required, such as utilizing it for braking analogue audio channels onto a Dante network. This LED illuminates when the power amplifier sections are turned OFF.

HINT: The amplifier can be brought out of standby by holding ENTER and QUIT at power-up.

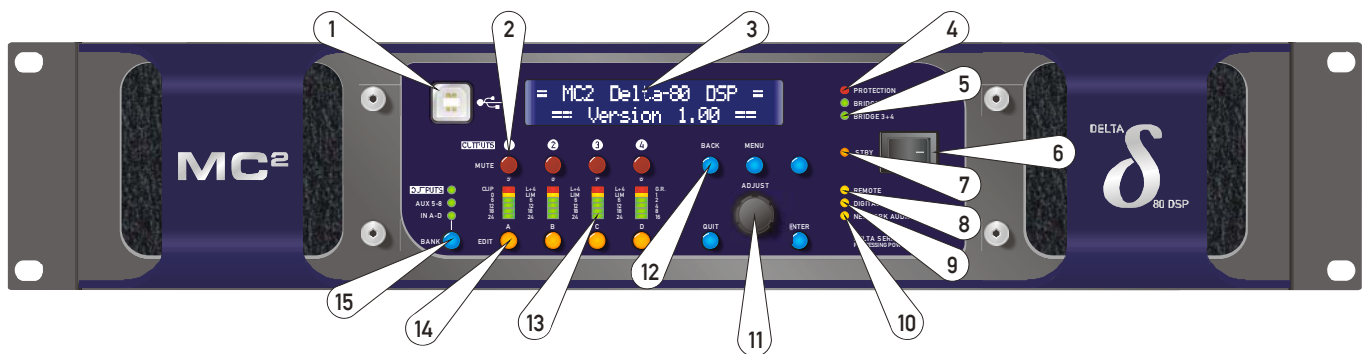

8: REMOTE LED: This will flash when the unit is being addressed under remote control.

9: DIGITAL IN LED: This illuminates if either AES input is switched in (replacing the respective analogue input channel) and will flash if there is a loss of lock on either input. Note that this does not mean AES is actually routed to the amplifier's DSP, only that a rear panel socket is set to receive an AES stereo signal.

10: NETWORK AUDIO LED: This will illuminate when an audio network connection is correctly made to the amplifier. Note that this does not mean that any network audio channels are actually routed to the amplifier's DSP, only that the connection is available.

11/12: Rotary encoder and navigation keys: MENU is always the way under the bonnet of the amplifier, and then BACK and NEXT to choose the Sub-Menu and ENTER to select the choice. These controls are also used when editing DSP audio parameters, accessed via the EDIT keys.

13: Signal meters: Depending on the current bank selected (#14), these will be showing input levels pre-DSP, output levels for the power amp channels, or output levels of the auxiliary channels.

14: EDIT keys: First press on an EDIT key will show the gain for the selected channel within its respective BANK. Second press will display the last edited parameter – see pages 25 to 27 for more info on full real-time editing of input and output parameters.

15: BANK Select key and LEDs: This key will cycle through three banks: inputs A-D, power amp outputs 1-4 or auxiliary outputs 5-8, for both meter displays, mute functions and during editing. Bank select will default to showing power amp outputs on meters and mutes after 20 seconds of inactivity.



## Operating Your Amplifier: Rear Panel Sockets and Switches

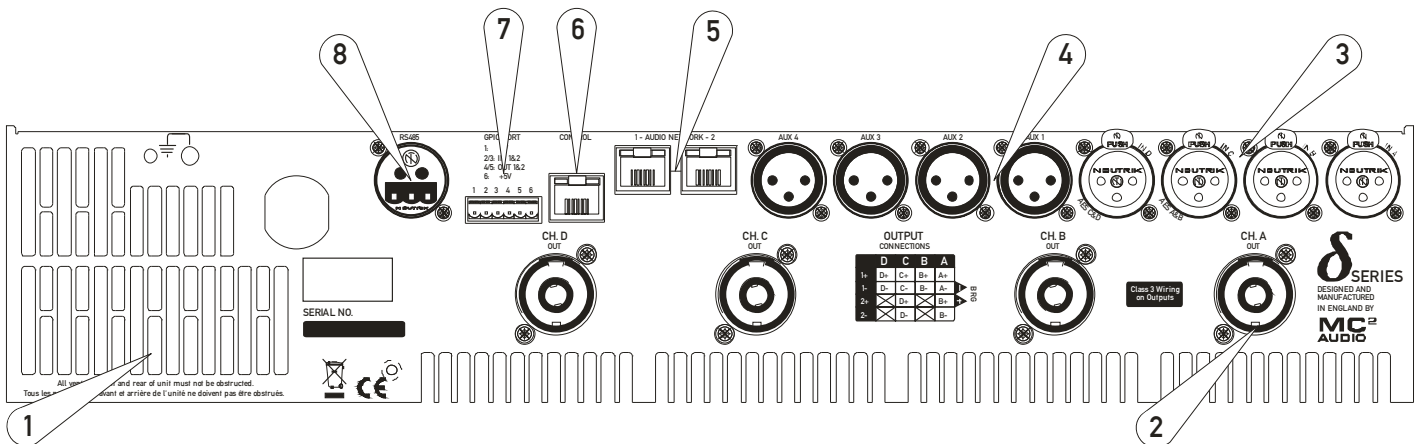

1: Fan outlet: The variable speed fans suck air in through the front vents and out through the back of the amplifier. Please see maintenance on page 56 for recommendations on how to clean this and the front foam sections.

2: Channel A output Speakon socket: Normal output is on pins 1+ hot, 1- cold. Channel B's output is also wired to this socket to enable a single NL4 to provide both channels and to facilitate easier wiring in bridged mode. Channel B is wired pins 2+ hot, 2- cold. Similarly channel C's output Speakon socket carries Channel D's output. Check the table on the rear panel for details.

3: Input XLR sockets: Connect signal inputs to these sockets, wired pin 2 hot, 3 cold, 1 ground. For sensitivity and impedance of these inputs, please see the specifications on page 57. Inputs C & D may also be switched to AES digital inputs, each carrying a stereo AES stream – channels A&B on socket C, channels C & D on socket D. This arrangement allows an analogue stereo source to remain connected to sockets A & B for fallback purposes. To select AES inputs please see the section on page 33.

4: Auxiliary output XLR sockets: These carry the four additional channels of separate DSP processing – they are NOT just link outputs or a copy of the power amplifier channel's processed audio – they are fully independent.

5: Audio network connections<sup>1</sup>: Four additional inputs can be added to the available input matrix via the optional Dante network card. This will also add four network audio outputs, which can be chosen (in banks of four) from a variety of processing points within the amplifier's DSP structure. For more on this feature see the block diagram on page 19 and set-up information from page 37.

6: Ethernet control port: Your amplifier may be remotely controlled by connecting it to a computer via this standard Ethernet port connection. Please see the section starting on page 46 for how to use this feature. HINT: You can quickly check the amplifier's IP address by pressing ENTER + NEXT.

7: GPIO Port: Your amplifier has a pair of general purpose logic level input and outputs that can be configured to recall memories, put the amplifier in standby, mute and control levels, and also provide feedback about status. Please see the section on page NN for more details.

8: RS485 Port: Your amplifier may also be controlled via an RS485 connection, and this port may also be used to relay control data from the Ethernet port or the front panel USB port to connect to further devices. Please see the remote control section on page 46 for more information.

<sup>1</sup> The audio network card is an option and may not be fitted to your amplifier.

## Operating Your Amplifier: Initial Set-up and Switching On

Please read all documentation before operating your amplifier and retain all documentation for future reference.

Do not spill water or other liquids into or on the unit and do not operate your amplifier while standing in liquid.

Do not block fan intake or rear ventilation outlets or operate the unit in an environment that could impede the free flow of air around the unit.

If your amplifier is used in an extremely dusty or smoky environment, it should be cleaned of any collected debris at regular intervals. Please also see the notes regarding maintenance on page 56.

It is important that the power output of your amplifier is matched to the power handling capacity of your loudspeaker. If not, damage to the loudspeaker could occur.

### *Switching On...*

The first time you switch it on, your amplifier will start-up as a four analogue inputs to four output system, with no EQ or limiting (apart from self-protective limiters) in place. The aux outputs will “mirror” the analogue inputs (and so initially act just like “link” outputs, again with no EQ or limiting in place).

The following section explains the DSP and audio features of the amplifier – please read this carefully as the routing options are very comprehensive!

Inside Your Amplifier: DSP Layout, Configurations and Routing

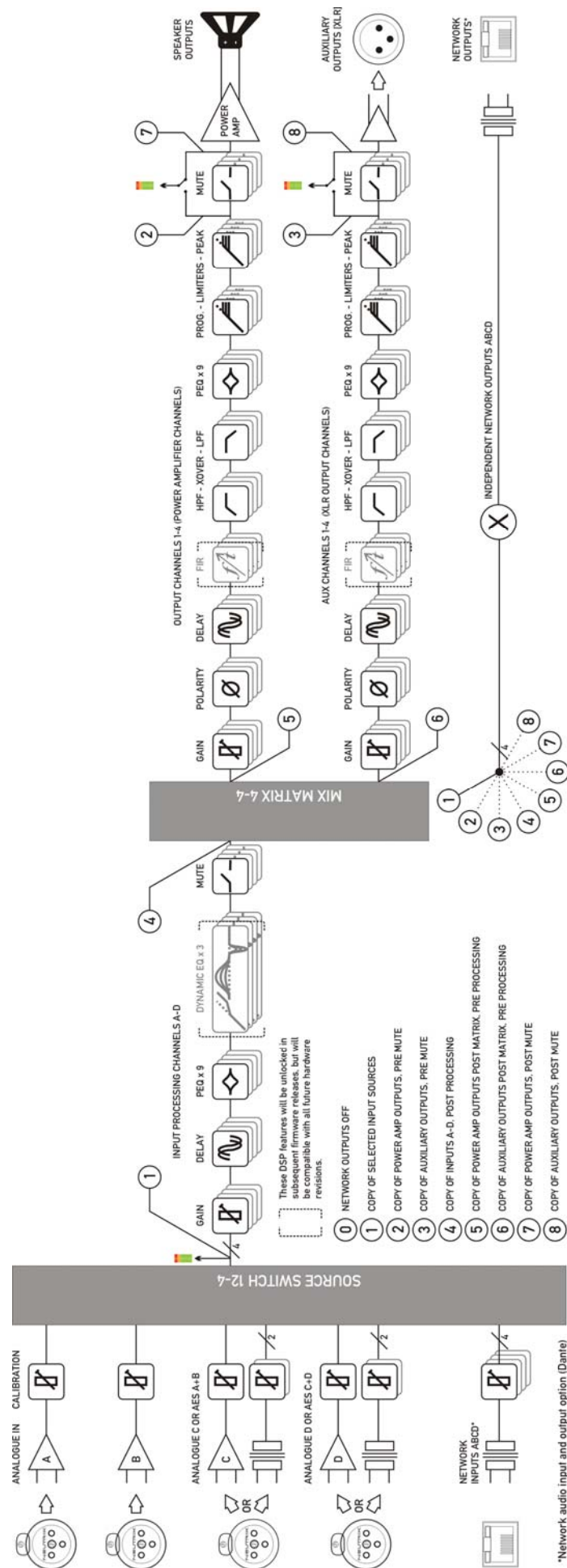

### Source Choices and Selection

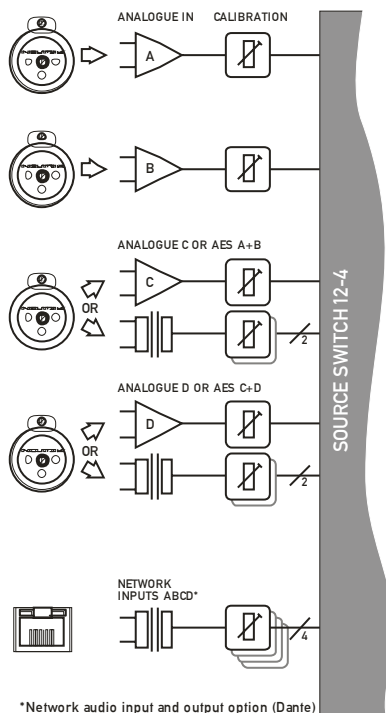

Your amplifier can source audio from analogue, AES digital, or network locations (if a network card is fitted).

Analogue and AES digital audio are standard, and arranged so that AES digital audio can be chosen in pairs of channels to replace either analogue inputs A&B together or analogue inputs C&D together, or all four channels.

Physical input of AES for channels A&B is swapped to the input XLR for channel C and the AES input for channels C&D is on the XLR socket for channel D.

In this way, a pair of analogue inputs can remain connected to channels A&B and a digital stream of the same audio can be connected to input C, with fallback from one to the other possible without repatching.

Assuming the network audio option is also fitted, four additional digital sources will then be available.

In total, 8 sources can be made available at any one time – four analogue and four digital. This affects the choices that can be made for routing to the inputs of the DSP channels.

The rules are as follows:

- Analogue A and B is available at all times;
- If AES A&B is selected, Analogue C cannot be used (shares XLR C);
- If AES C&D is selected, Analogue D cannot be used (shares XLR D);
- If AES A&B is chosen, Dante A&B cannot be used (shares SRC One);
- If AES C&D is chosen, Dante C&D cannot be used (shares SRC Two);

Source selection is therefore affected by the selection of AES inputs, which then controls the choice of input source selections on offer to any input processing channel.

Please see page 32 for further info on using the AES and Input source selection menu options.

### Input Processing Channels

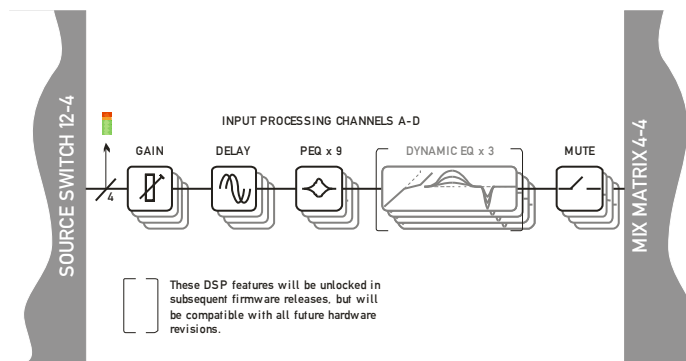

Your amplifier has four input channels of processing that can be fed from a variety of sources.

These four channels in turn, feed a mix matrix for routing to the power amplifier processing channels and the auxiliary output processing channels.

Each input processing channel consists of the following sections:

- Input gain control
- Input delay time
- Input parametric EQ bands 1 through 9

The dynamic EQ sections will be added in a future firmware update. For more information on adjusting input processing parameters, please see the section beginning on page 25.

### Mix Matrix Section

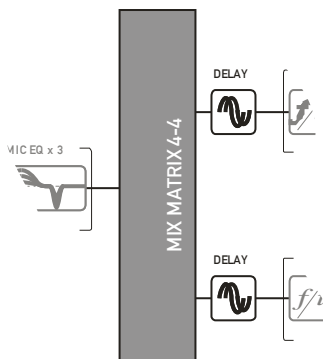

The mix matrix allows four independent mixes to be set up for the power amplifier channels and the auxiliary output channels.

These can be either “Boolean” in design (so just A+B+C etc.) or a full mix matrix mode can be used to allow four continuously variable “sends” from the four input processing channels to be combined.

There are also a variety of templates to act as starting points for crossover duties, where useful crossover (high and low pass) frequencies are automatically assigned to groups of outputs, dependant on the format used. For more information on adjusting the mix matrix, please see the output editing section on page 31. Note that the mix matrix will only be available if it has been selected as part of the output/auxiliary configurations – see page 37 to change this.

### Power Amplifier and Auxiliary Output Processing Channels

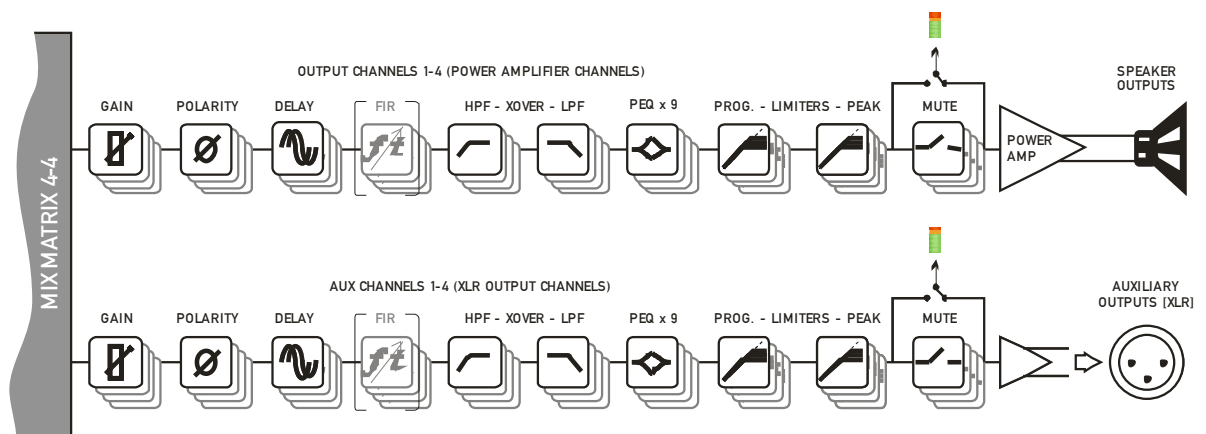

There are eight identical channels of output processing in your amplifier: four dedicated to the power amplifier channels, and a further four that are connected to the auxiliary XLR outputs on the amplifier, providing analogue feeds to other equipment.

Each output processing channel consists of the following sections:

- Output delay time
- High and low pass crossover filters (up to 48dB/Oct.)
- Output parametric EQ bands 1 through 9
- Output gain control
- Program (RMS) limiter
- Peak limiter

FIR filtering capabilities will be added in a future firmware update. For more information on adjusting output processing parameters, please see the section beginning on page 27.

## Independent Network Audio Outputs

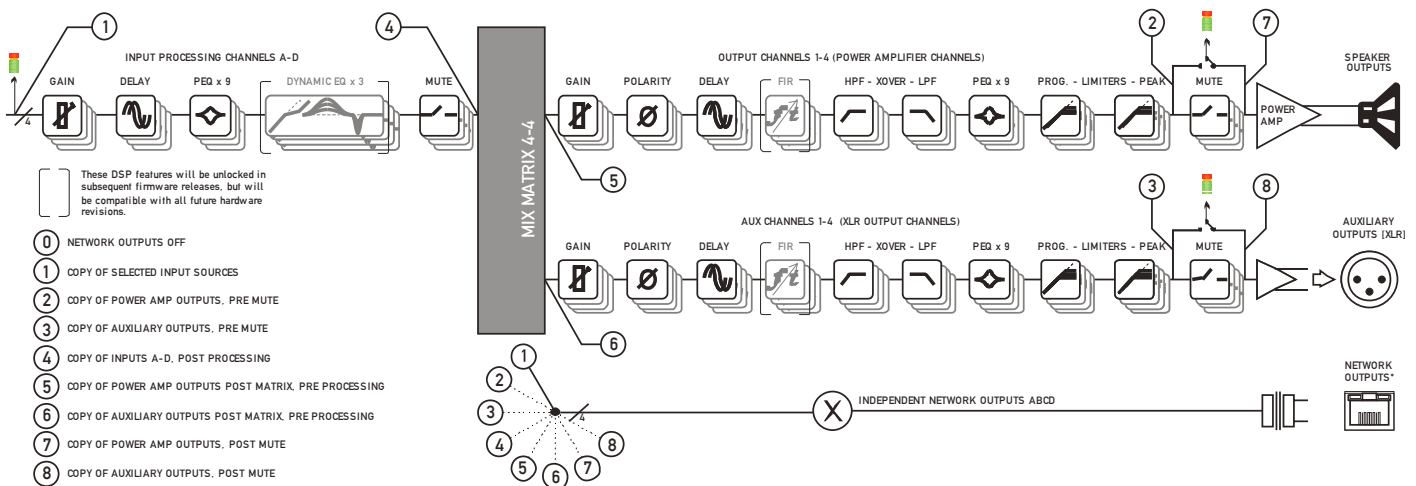

If your amplifier has a network audio card fitted (Dante) then, as well as being able to route four channels of audio from the network, it is possible to route four channels of audio back onto the network.

This feature is primarily intended for use with the Delta NON-DSP models, which may also be fitted with a network audio interface, allowing them to utilise the additional processing channels in your Delta 80 DSP via connection with a single Ethernet cable.

Working like this, the network audio outputs would be routed directly from end of the auxiliary output processing, so that they are just a copy of the signals available at the Aux XLR outputs 1-4 (choice #1 in the above diagram).

However, there are other circumstances where it might be more useful to route these outputs from elsewhere within the DSP processing. For example, if the network outputs are being used to also “break-in” analogue or AES channels, for use with other amplifiers, it might be more applicable to route the audio from the outputs of *input* processing channels (choice #5).

If it’s required for the network outputs to break in channels that are not being used by the local processing, this can also be achieved by using the outputs of the mix matrix which feed the auxiliary output processing (choice #3).

Alternately, the mixes being used by the power amp processing can be selected (choice #4) and finally, the pre-mute final output of the auxiliary channels’ processing may be selected (choice 2) to prevent muting the local aux outputs from muting the network feeds.

**Note that these routing selections work on a “x4” basis – all four network output feeds are selected from one of the above choices as a group – they cannot be individually assigned to different points.**

For more information on selecting the network audio output routing, please see the section on page 35.

## Operating Your Amplifier: Directly Editing Audio Parameters

### Overview

Editing all audio parameters is available from the front panel of your amplifier using a combination of the select BANK key, reassignable EDIT keys, and the BACK/NEXT/ENTER navigation controls.

First, make sure the correct bank of channels is selected – either inputs A-D, amplifier outputs 1-4 or auxiliary outputs 5-8 by pressing the BANK key.

Next, press the EDIT key that corresponds to the channel to be adjusted. The EDIT key will illuminate, and the gain will always be displayed as the first parameter.

To choose another parameter, use BACK and NEXT to scroll through the available choices.

If there are multiple parameters grouped on a single screen (such as parametric EQ frequency, 'Q' and gain) move between these using the ENTER key.

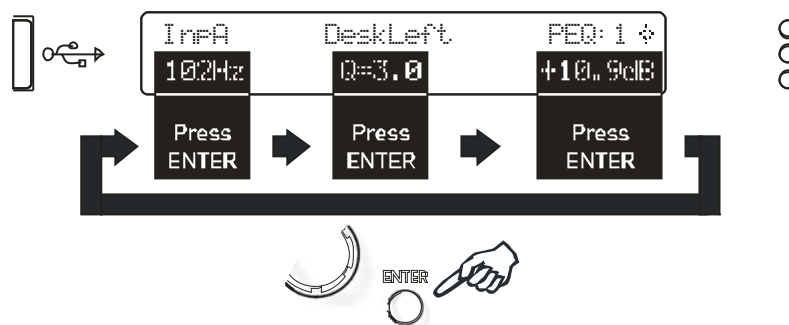

Finally, use the rotary encoder to adjust the value of the parameter.

You can swap bank at any time by pressing the BANK key, and to quickly access the same parameter on another channel (within a bank) double press on the required channel's EDIT key. If the same parameter doesn't exist in a bank (such as no limiters on the input bank), the gain screen will be shown.

A third press on the same EDIT key will exit editing and return to the current bank's default screen.

Hint: You can quickly check the same setting of any parameter on a bank of channels by double pressing each EDIT key in turn – so to check each output's polarity setting, just press EDIT, press NEXT until Polarity is displayed, then press the next channel's EDIT twice, and so on.



### Input Gain

Variable between -40dB and +6dB in 0.1dB steps.

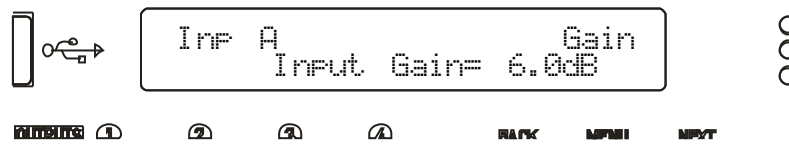

### Input Delay

Max delay time is 650.000mS in 10uS steps. Swap to 1mS steps by pressing ENTER. Units can be changed to read distance instead of time though the system sub-menu – see page 43 for details.

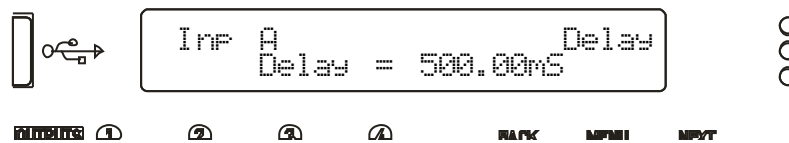

### Input Parametric EQ Bands 1 through 8

All parametric bands cover a frequency range of 19.7Hz to 32kHz when in standard PEQ mode. Some restrictions apply when other filter types are selected. Move between frequency, 'Q' and filter gain by pressing ENTER. Press and HOLD the ENTER key whilst pressing QUIT to bypass a band and also access different filter types.

◇	PEQ	Parametric EQ
>	LSF	Low Shelf
<	HSF	High Shelf
^	BPS	Band Pass
v	NOT	Notch
⊙	APF	All Pass
⊙	PHF	Phase
~	LPF	Low Pass VariQ
~	HPF	High Pass VariQ
~	LPF	Low Pass Elliptical
~	HPF	High Pass Elliptical

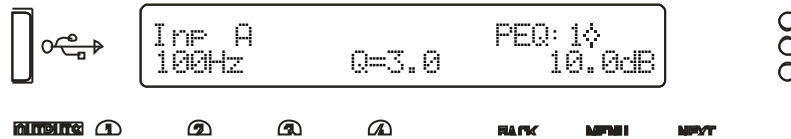

A filter must be in Bypass before its type can be changed. Once bypassed, the ENTER key will allow access to the type list and this can be adjusted with the encoder, scrolling through the types listed above.

### Output Gain

Variable between -40dB and +15dB in 0.1dB steps.



### Output Polarity

Switch between normal [+] and inverted [-] polarity. Note that channel ganging is temporarily disabled for polarity adjustments.

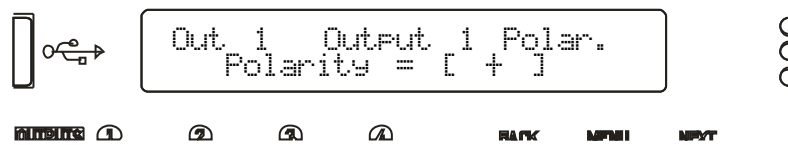

### Output Delay

Max delay time is 650.000mS in 30nS steps. Swap to 1mS steps by pressing ENTER. Units can be changed to read distance instead of time though the system sub-menu – see page 43 for details.



*Output High Pass Filter*

Set the high pass filter frequency – a setting of “<10Hz” bypasses the filter. To change the filter slope and type, press ENTER and then adjust with the encoder. Note that 48dB/Octave filters will only be available if PEQ 6 & 7 are bypassed.

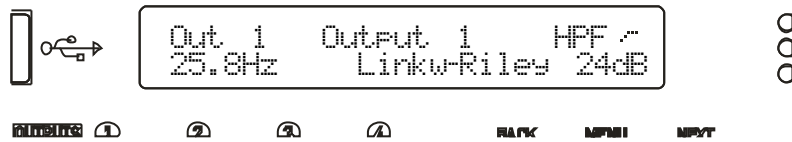

Parametric bands will remember their settings if bypassed and used in 48dB/Octave crossover filters and these settings will be reinstated if a lower order filter type is subsequently chosen (24dB/Octave or lower).

The message

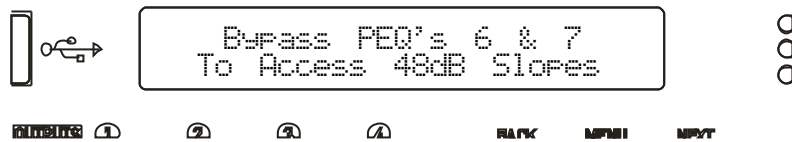

will be shown if the bands aren't already in bypass (or set to 0dB).

*Output Low Pass Filter*

Set the low pass filter frequency – a setting of “>32kHz” bypasses the filter. To change the filter slope and type, press ENTER and then adjust with the encoder. Note that 48dB/Octave filters will only be available if PEQ 8 & 9 are bypassed.

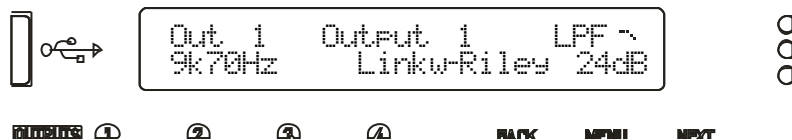

Parametric bands will remember their settings if bypassed and used in 48dB/Octave crossover filters and these settings will be reinstated if a lower order filter type is subsequently chosen (24dB/Octave or lower).

The message

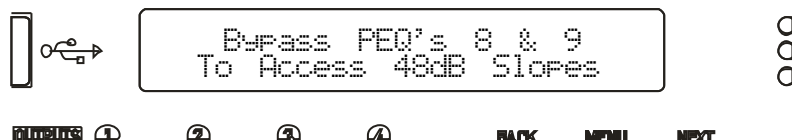

will be shown if the bands aren't already in bypass (or set to 0dB).

*Output Parametric EQ Bands 1 through 9*

All parametric bands cover a frequency range of 19.7Hz to 32kHz when in standard PEQ mode. Some restrictions apply when other filter types are selected. Move between frequency, 'Q' and filter gain by pressing ENTER. Press and HOLD the ENTER key whilst pressing QUIT to bypass a band and also access different filter types.

◇	PEQ	Parametric EQ
>	LSF	Low Shelf
<	HSF	High Shelf
Λ	BPS	Band Pass
∇	NOT	Notch
⊖	APF	All Pass
⊕	PHF	Phase
~	LPF	Low Pass VariQ
~	HPF	High Pass VariQ
~	LPF	Low Pass Elliptical
~	HPF	High Pass Elliptical

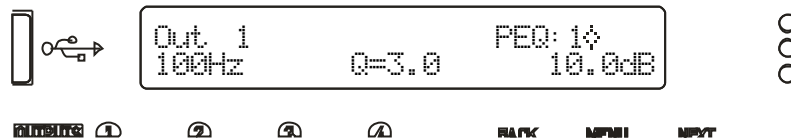

Parametric bands missing? If bands 6 and 7, or 8 and 9 are missing when editing, it is because they are being utilised by high order crossover filters – high pass filter orders above 24dB/Octave will disable and hide bands 6 and 7, and low pass filter orders above 24dB/Octave will similarly remove bands 8 and 9.

These bands will be reinstated if the respective crossover filter order is reduced to 24dB/Octave or lower.

A filter must be in Bypass before its type can be changed. Once bypassed, the ENTER key will allow access to the type list and this can be adjusted with the encoder, scrolling through the types listed above.

### Output Limiters: Program Limiter

Note that the output limiters are calibrated differently for the amplifier output channels and the auxiliary output channels. They cover the same range, but the scaling on the threshold is different as the auxiliary outputs are calibrated to the maximum line output level, whilst the amplifier outputs are calibrated to include the gain of the power amplifier.



Move between the attack time, the release time and the threshold by pressing the ENTER key. If the message “Automatic T/C” appears on the limiter edit screen, this means that the limiters time constants have been set to be configured automatically, based on the frequency of this channel’s high pass crossover filter.

To turn this feature off, and use manual attack and release times, please see the section on page 37 describing amplifier and auxiliary routing.

Release time is set as a multiplier of the attack time, so is represented as a “time N” readout. The minimum release time is twice the attack time, to minimise audible artefacts of inappropriate limiter time constants. We recommend using the automatic feature unless there is a good reason not to – a badly set up limiter will not only function incorrectly, and not provide the protection you expect, it can also sound pretty terrible!

Setting up limiters has perhaps been seen as a “black art” by some engineers – it is actually a simple process, as long as you have a few basic pieces of information to hand. Please read through the section on limiters and how to set them correctly, starting on page 60 of this manual.

### Output Limiters: Peak Limiter

The peak limiter immediately follows the program limiter in an output (both power amplifier and auxiliary) signal path. It is designed to control the peaks that pass through the program limiter, due to the attack time set on the program limiter. A slow attack time will allow the program limiter to exceed its threshold for a short period, and this may cause over excursion on LF drivers. This may be controlled by imposing an absolute maximum level, set in dB above the program limiter threshold. This limiter has a zero overshoot characteristic and so only has a release parameter (with no attack time).

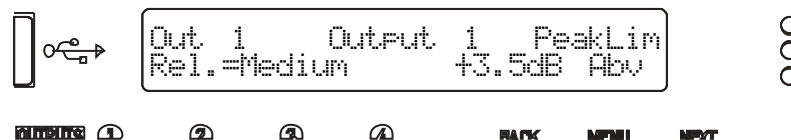

Toggle between release time (Slow/Medium/Fast) and the threshold above the Program limiter by pressing the ENTER key. If the release time is replaced with “Rel.=Auto”, this means that the limiters time constants have been set to be configured automatically, based on the frequency of this channel’s high pass crossover filter. Please see the section on page 37 describing amplifier and auxiliary routing, if you want to revert to manual release time.

### Output Matrix Gains

Note that this feature will only be displayed if the configuration for the amplifier or auxiliary outputs has been set to operate in “Full Matrix” mode , as opposed to “Free Assign” or a standard routing configuration (1 x 4 way, 2 x 2 way etc.)

To use “Full Matrix” mode, please see the section about adjusting the configuration on page 37.



Initially, the “send” level from Input A will be selected – press ENTER to jump to the next “send” level for this output. Range is from -40dB to +15.0dB, with Mute one step below -40.0dB, whereupon the display will show “Off” as for Input B’s send level in the above example.

## Operating Your Amplifier: Advanced Editing Features

### Overview

In addition to being able to control all the EQ and limiter functions via the front panel, it is also possible to completely reconfigure the source selections and routing, turn on matrix mixing, and configure ganging options to speed up editing.

The routing and ganging options are independent for the amplifier outputs and auxiliary outputs, but source selection is global across the entire device.

### Selecting Available Sources (Analogue, AES, Network Audio)

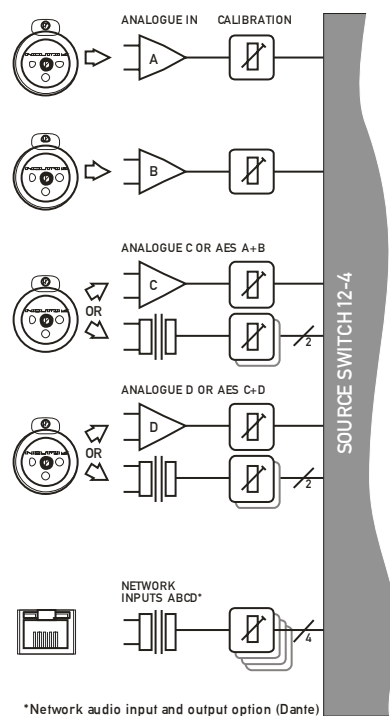

Your amplifier can source audio from analogue, AES digital, or network locations (if a network card is fitted).

Analogue and AES digital audio are standard, and arranged so that AES digital audio can be chosen in pairs of channels to replace either analogue inputs A&B together or analogue inputs C&D together, or all four channels.

Physical input of AES for channels A&B is swapped to the input XLR for channel C and the AES input for channels C&D is on the XLR socket for channel D.

In this way, a pair of analogue inputs can remain connected to channels A&B and a digital stream of the same audio can be connected to input C, with fallback from one to the other possible without repatching.

Assuming the network audio option is also fitted, four additional digital sources will then be available.

In total, 8 sources can be made available at any one time – four analogue and four digital. This affects the choices that can be made for routing to the inputs of the DSP channels.

The rules are as follows:

- Analogue A and B is available at all times;
- If AES A&B is selected, Analogue C cannot be used (shares XLR C);
- If AES C&D is selected, Analogue D cannot be used (shares XLR D);
- If AES A&B is chosen, Dante A&B cannot be used (shares SRC One);
- If AES C&D is chosen, Dante C&D cannot be used (shares SRC Two);

Source selection is therefore affected by the selection of AES inputs, which then controls the choice of input source selections on offer to any input processing channel. Switch any required AES sources first, then select the required source combination.



*Switching from Analogue to AES Sources*

To select inputs, from the home screen, press MENU, choose the CONFIGURATION Sub-Menu and press ENTER.



Use the encoder or BACK and NEXT keys to find the Input AES Selection option and press ENTER.

The screen will now show the current choice for the physical XLR inputs on channels C&D:



Use the encoder or BACK and NEXT keys to cycle between the four combinations, of analogue (Ana) or Digital (AES). Press ENTER to confirm the choice, and again to confirm if changes have been made.



If a digital source is chosen for either XLR, the AES IN LED on the front panel will begin to flash until a valid lock is seen for the selected inputs.



If the AES input(s) have valid stable signals and there are no other issues, the LED will not be flashing.



**Note that the AES LED being illuminated does NOT mean that an AES source is being used or routed anywhere within the amplifier. It is an indication that valid AES is connected.**

### Choosing Sources to Route to Input Processing Channels

To choose sources, from the home screen, press MENU, choose the CONFIGURATION Sub-Menu and press ENTER.



Use the encoder or BACK and NEXT keys to find the Input Source Selection option and press ENTER.

The screen will now show the current choice for the first input processing channel (A):



Use the encoder or BACK and NEXT keys to scroll through the eight choices for this input. These will be:

Four analogue sources:

Analogue A  
 Analogue B  
 (Analogue C)  
 Analogue D

And four digital sources, depending on the AES selection:

AES A  
 AES B  
 (Dante C)  
 (Dante D)

The choices shown above would be shown if AES has been selected on XLR C. Analogue C is shown in brackets to indicate that this selection will result in no audio, either because the input is currently unavailable (due to input selection choices in the case of Analogue C) or because the input does not exist (due to the network audio card not being fitted in the case of the Dante C and Dante D).

Press ENTER when the required input source is shown, and the next processing channel will be selected, running through input channels A-D. Finally, if anything has been changed, the confirmation screen will show:

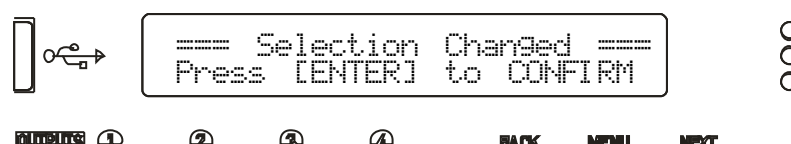

Press ENTER to confirm the changes and exit to the home screens.

## Changing Network Output Source

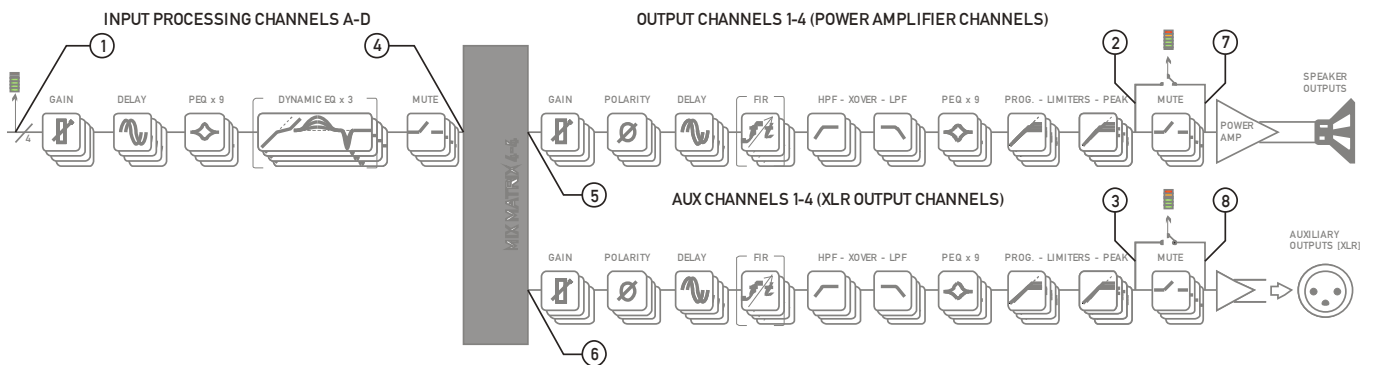

If your amplifier has a network audio card fitted (Dante) then, as well as being able to route four channels of audio from the network, it is possible to route four channels of audio back onto the network. The possible sources for the network outputs are always selected as a group of four, and there are eight points within your amplifier's DSP that can be chosen.

To choose sources, from the home screen, press MENU, choose the CONFIGURATION Sub-Menu and press ENTER.



Use the encoder or BACK and NEXT keys to find the Digital Output Source option and press ENTER.

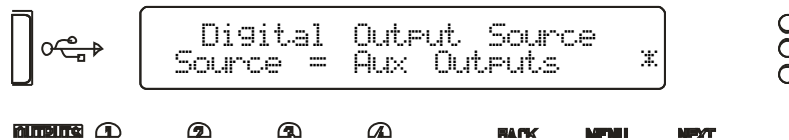

Use the encoder or BACK and NEXT keys to choose between one of the following sources:

### Off (Muted)

The network outputs source is disconnected and no audio is transmitted. The Dante connection is maintained and visible on the network

### Inputs

Source ①: audio is sourced from the input to the DSP, just after the source switching matrix, before any processing.

### Amp Outputs

Source ②: audio is sourced just after all amplifier output's processing but *pre-mute* so the network copies will *not* be affected by local (or remote) mutes.

### Aux Outputs

Source ③: audio is sourced just after all auxiliary output's processing but *pre-mute* so the network copies will *not* be affected by local (or remote) mutes.

### Matrix Inputs

Source ④: audio is sourced just after all input channel's processing but before the mix matrix – network outputs will be affected by input mutes.

## Changing Network Output Source cntd...

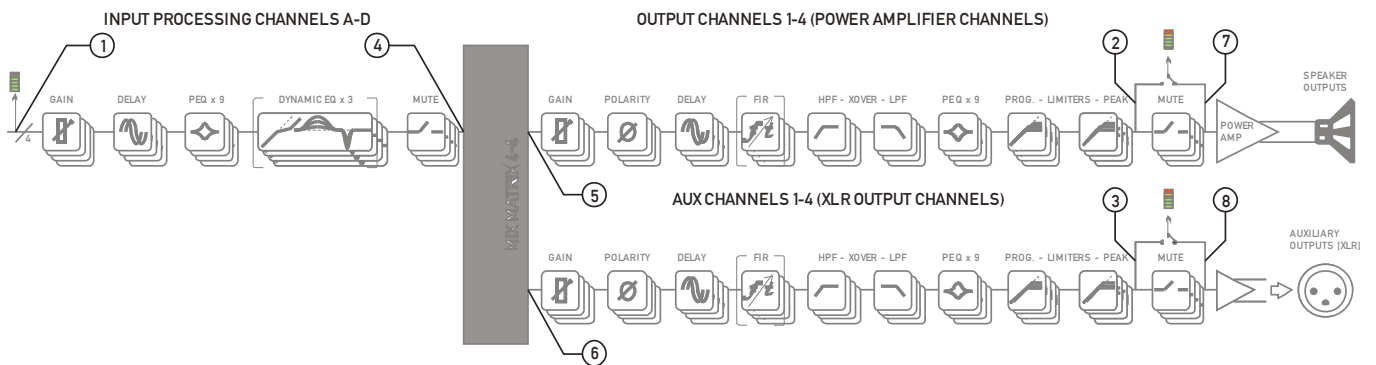
**Amp Matrix**

Source ⑤: audio is sourced just after the auxiliary output's routing matrix (so will share the same audio feeds) but before all output processing.

**Aux Matrix**

Source ⑥: audio is sourced just after the amplifier output's routing matrix (so will share the same audio feeds) but before all output processing.

**Amp Outputs+M**

Source ⑦: audio is sourced just after all amplifier output's processing *post-mute* so the network copies will be affected by local (or remote) mutes.

**Aux Outputs+M**

Source ⑧: audio is sourced just after all auxiliary output's processing *post-mute* so the network copies will be affected by local (or remote) mutes.

Press ENTER to confirm the changes and exit to the home screens.

### Changing Crossover Configuration

As the amplifier output's configuration setup is identical to the auxiliary output's configuration, this section will just explain the former. The configuration of the amplifier outputs 1-4, and auxiliary outputs 1-4 have separate entries in the Configuration sub-menu, but operate identically. Once the input sources and AES selections have been set up, the last part of the process is to determine what actual routing configuration is required from the "outputs" of the four input processing channels.

This is the mix matrix. The mix matrix can function either in a "Boolean" operation mode, where input signals still have the capability to be mixed together to feed an output channel's processing, but at fixed standard levels, or as a fully variable mixer.

There is also a selection of useful templates if used in the "Boolean" mode, which will preconfigure not only the routing, but also useful starting points for each outputs' crossover filters.

To change configuration, from the home screen, press MENU, choose the CONFIGURATION Sub-Menu and press ENTER.



Use the encoder or BACK and NEXT keys to find the Output Routing option and press ENTER.



Use the encoder or BACK and NEXT keys to choose from the following routing options:

#### Full Matrix

This mode offers continuously variable send levels from the four input processing channels and the adjustment of the levels is then through individual output editing as explained on page 31.

#### Free Assign

This mode allows the input sends to be selected as ON or OFF and intelligently adjusts the send levels to maintain 0dB on the output – this is further explained on the next page.

#### 1 x 4 WAY

All four outputs are fed from input processing channel A's output and assigned default crossover points, which may then be adjusted if required.

#### 2 x 2 WAY

Outputs 1 & 2 (or Aux 5 & 6) are fed from input processing channel A's output, and outputs 3 & 4 (or Aux 7 & 8) from channel B. Default crossover points are assigned.

#### 4 x 1 WAY

Input processing channel A feeds output channel 1, B to 2, C to 3 and D to 4.

Crossover points are not assigned and will be set to full range – this can be changed manually if required.

*Using Free Assign Mode*

Free assign mode allows any combination of inputs to be routed to an output, with the send levels being intelligently adjusted to ensure that the output levels sum to 0dB.

So, if two inputs are summed to a particular output, their gains will be dropped by 6dB so that if both input levels are 0dB they will sum to produce a 0dB level at the output (assuming the output gain as not been adjusted by the user).

If three inputs are summed, their gains will be reduced by 9.5dB so if all three inputs are 0dB, so the output will be 0dB.

Lastly, if all four inputs are summed to an output channel, the gains will be reduced by 12dB.

If this method of operation is not desired, the same summing can be achieved without the automatic gains adjustments by switching to Full Matrix mode and manually setting the send levels as required.

Select Free Assign mode when changing the output routing (separately for power amp outputs and auxiliary outputs).

To change configuration, from the home screen, press MENU, choose the CONFIGURATION Sub-Menu and press ENTER.

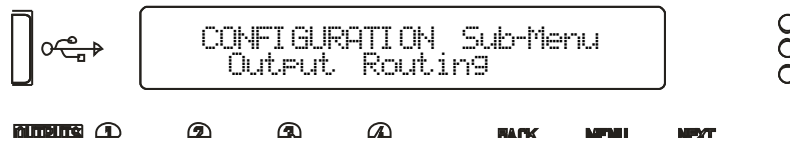

Use the encoder or BACK and NEXT keys to find the Output Routing option and press ENTER.

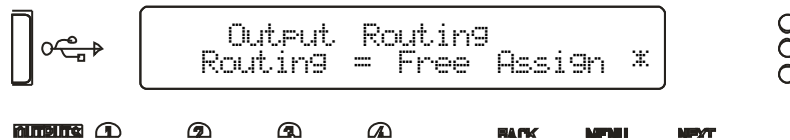

Use the encoder or BACK and NEXT keys to choose Free Assign and press ENTER. The first MUTE key will begin to flash and the EDIT keys will illuminate to show which input processing channels are being routed to this output as well as being show on-screen. In the example below, output 1 is being fed from A+D:

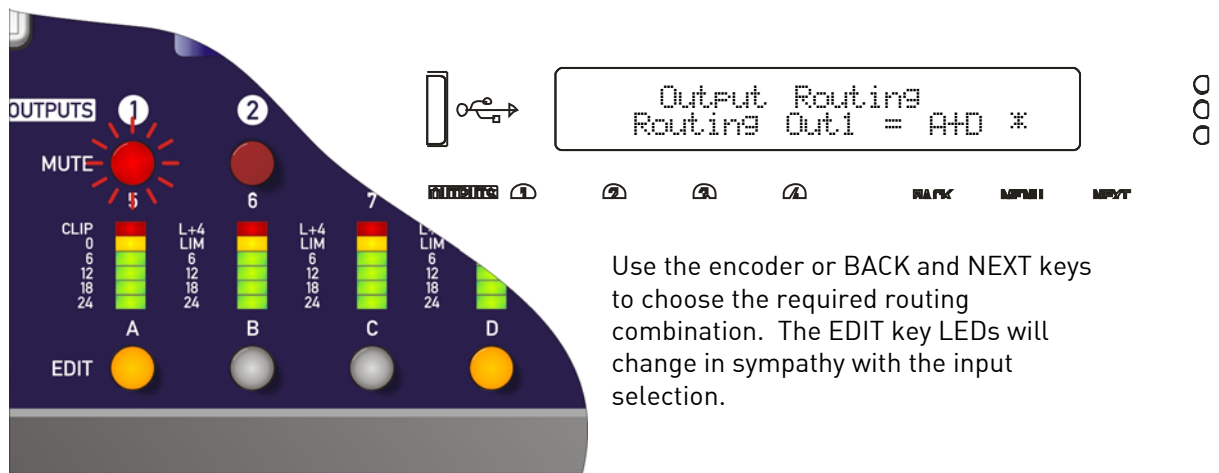

Use the encoder or BACK and NEXT keys to choose the required routing combination. The EDIT key LEDs will change in sympathy with the input selection.

Press ENTER to move on to the next output channel or press the channel's MUTE key to select it. When all channels have been routed, press ENTER – the unit will run through any remaining channels (if output 3 had been manually selected, for example, then ENTER would run through channel 4 before moving on to the final set-up selections).

The next set-up selections are concerned with using automatic time constants for the limiters and selecting bridged configurations.

The screen will first show:



MC<sup>2</sup> advise setting the limiter time constants automatically. They are based on the frequency of this channel's high pass crossover filter. Unless you have a particular reason to not use the auto setting, set this to YES and press ENTER.

### *Bridged Mode for Output Pairs*

Output pairs can be selected to run in a bridged configuration to realise higher output powers.

When operating in bridged mode, the minimum impedances are doubled.

**The minimum load in bridged mode is 4 ohms.**

For details of how to connect to the amplifier when running in bridged mode, please see page 14.

Selecting bridged mode is available through the CONFIGURATION > Output Routing menu and as part of the set-up wizard. Bridged mode is not available for auxiliary output configuration and should instead be selected on the externally driven "slave" amplifier.

The screen will show:

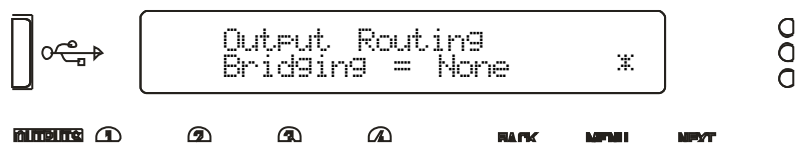

Use the encoder to select which channel pairs are to be bridged:

- 1<>2 - bridge outputs 1 & 2 only
- 3<>4 - bridge outputs 3 & 4 only
- 1<>2 & 3<>4 - bridge both output pairs

Confirm selection with ENTER – final section of the configuration wizard will then ask about resetting/clearing parameters as explained in the next section. If a bridged mode has been selected there are some changes apparent in the interface to confirm this.

Depending on what bridged mode are active the appropriate LED will illuminate above the power switch:



There are some changes operationally when a pair of channels are bridged.

Channel MUTE keys will be automatically ganged;

Meters for the bridge pair will read identically;

and lastly

Channel EDIT keys will be automatically ganged, and the display reflects the bridged mode by changing to show the following when a bridged pair are edited:

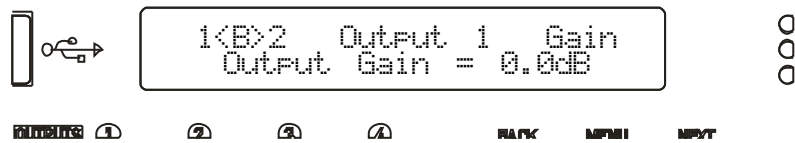

In this example, the bridged pair are outputs 1 & 2 and this will be displayed if EDIT is pressed on either output channel.

Bridged status is stored in an output memory, and ignored if this memory is recalled into the auxiliary channels.



### Resetting Audio Parameters

Resetting parameters is available through the CONFIGURATION > Output Routing menu and CONFIGURATION > Auxiliary Routing menu as part of the set-up wizard.

The final set-up query is about resetting the current parameters. If you have already edited the outputs' DSP settings and are setting up routing last, make sure you select "No" when asked about resetting, or all your filter, delay limiter and crossover parameters will be cleared!



If "Yes" is selected, then, depending on format chosen, **all outputs will be set to full range (no crossover), limiters at max threshold (so minimum protection), delays and gains at zero, polarity normal and all bands of EQ to PEQ mode, 1kHz, Q of 3.0 and 0dB. All output/auxiliary channels will also be muted for safety!**

Certain formats will preset the crossover frequencies to give a useful starting point:

Selecting a 2 x 2 way configuration will preset the output crossovers as  
 Outputs 1 + 3: <10Hz – 1.62kHz, 24dB/Oct. Link-Riley  
 Outputs 2 + 4: 1.62kHz - >32kHz, 24dB/Oct. Link-Riley

Selecting a 1 x 4way configuration will preset the output crossovers as  
 Output 1: <10Hz – 149Hz, 24dB/Oct. Link-Riley  
 Output 2: 149Hz – 1.31kHz, 24dB/Oct. Link-Riley  
 Output 3: 1.31kHz – 8.00kHz, 24dB/Oct. Link-Riley  
 Outputs 4: 8.00kHz – >32kHz, 24dB/Oct. Link-Riley

In both cases, all other DSP functions are reset as in **bold** above.

Hint: This procedure can be used to quickly clear all EQ – simply run through all the steps of either output or auxiliary routing as appropriate without changing anything and select "Yes" when asked about clearing output settings.

### Ganging Channels for Editing

To make editing of multiple channels simpler (for example, stereo input sources or two-way output editing), it's possible to gang channels together so that any edits applied to one will automatically be applied to the other (or others).

Ganging is separated for inputs, outputs and auxiliary channels, but the method of setting them up is identical so only the output ganging option will be covered here.

To change output ganging, from the home screen, press MENU, choose the CONFIGURATION Sub-Menu and press ENTER.



Use the encoder or BACK and NEXT keys to find the Output Ganging option and press ENTER.

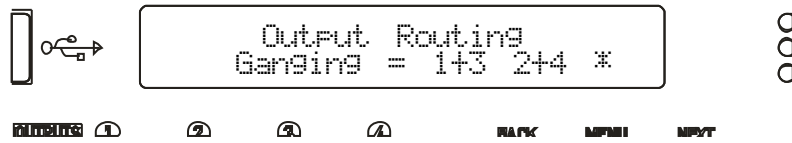

Use the encoder or BACK and NEXT keys to choose the required ganging option and press ENTER. If the ganging mode has changed, confirm this with a final press of ENTER and the ganging is complete.

Note that ganging assumes the settings of the lowest numbered channel in the gang is the initial master channel and so any changes to ganging will immediately copy the settings from the lowest member in the gang to all other ganged channels.

For example – adding channel 3 to a gang of 1+3 will instantly make channel 3's settings identical to channel 1.

Mutes remain unganged at all times (except in bridge mode – see page 39), as does polarity.

Ganged channels are indicated by the EDIT keys illuminating together and the display showing the member numbers of the gang:



The label shown ("Extern 1") is always the lowest gang member, no matter which EDIT button has been pressed in the gang.

Labels can only be changed through remote control software or the DeltaDirect iPad app.

Ganging states are stored in output memories and will be recalled when an output memory is recalled to either amplifier outputs or auxiliary outputs.

## Operating Your Amplifier: Storing and Recalling Settings

### Memory Overview

The memory in your amplifier is organised into three different types – input memories, output memories and source memories. Input and output memories are formatted in banks of four channels at a time – be that four input channels or four output channels (amplifier or auxes). Source memories are a different type and are global to the entire amplifier. It is also possible to store and recall a complete copy of all current settings (so, input, source, amplifier and aux outputs) in a memory location – “Everything”.

Input memories contain all the EQ, gains, delays, mutes and names for the four input channels.

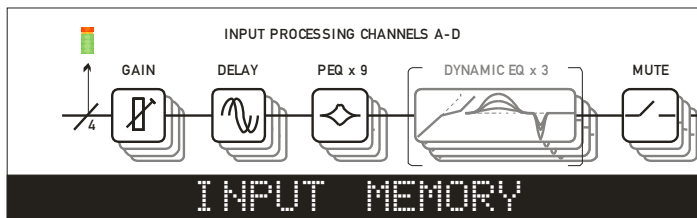

Output memories contain all the EQ, crossover filters, FIR data (if applicable), polarities, gains, delays, mutes, limiters (including auto time constants setting), names, bridge modes, and routing from the mix matrix (including free assign and full matrix gains if applicable). This is for the bank of four amplifier channels, or the bank of four auxiliary output channels.

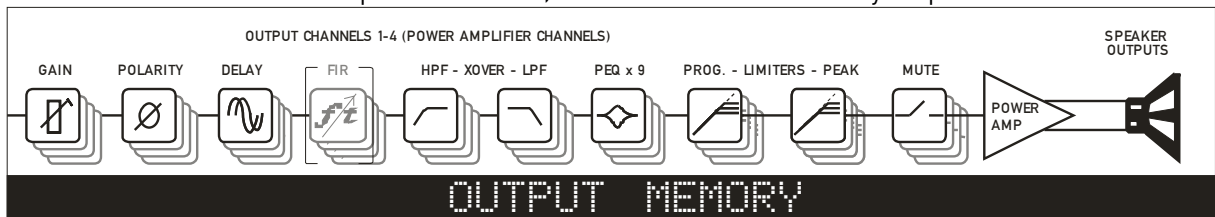

Source memories contain the all data concerned with additional choices of source selection encompassing AES/Analogue switching, Network Audio Output Source and the source switching (choosing which inputs feed the input DSP channels).

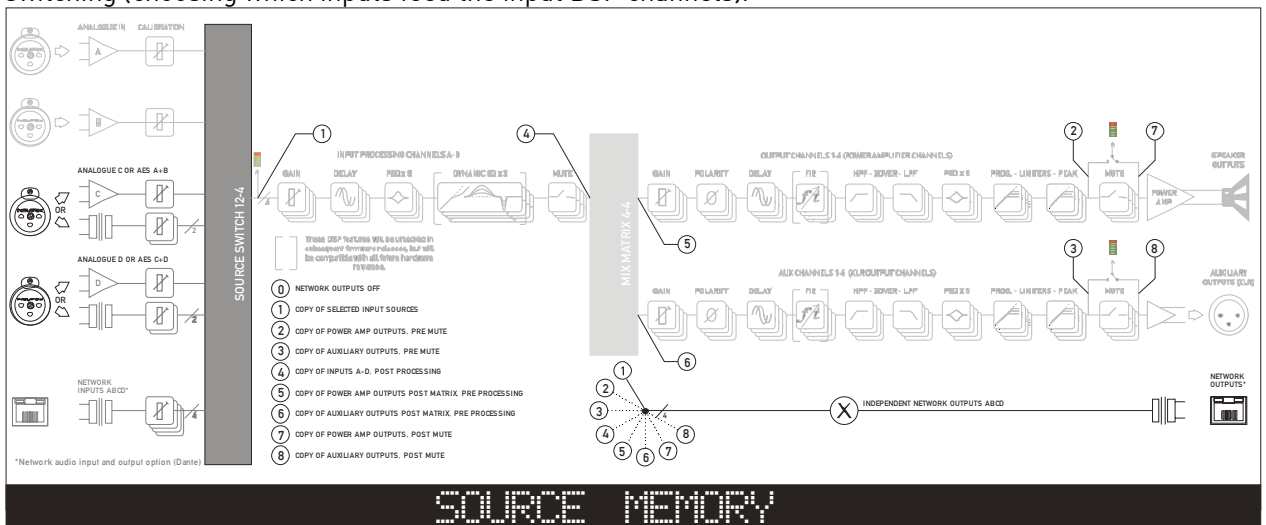

Memories all exist in a numbered list and depending on the type of memory to be recalled, the list will be filtered to only show the applicable memory type.

### Storing a Memory...

When a memory is to be stored, the type is first selected (Input, Output, Source or Everything) and then in the case of an Output memory, this must be further qualified to determine if the stored data is to originate from the amplifier outputs or the auxiliary outputs.

To store a memory, from the home screen, press MENU, choose the GLOBAL MEMORY Sub-Menu and press ENTER.



Use the encoder or BACK and NEXT keys to choose either Input or Output memory type as appropriate and press ENTER.

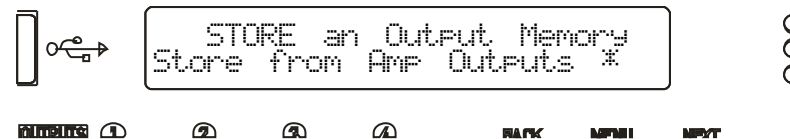

In the previous example, the extra step is to choose whether to store the four amplifier outputs' data, or the four auxiliary outputs' data. Choose with encoder and press ENTER.

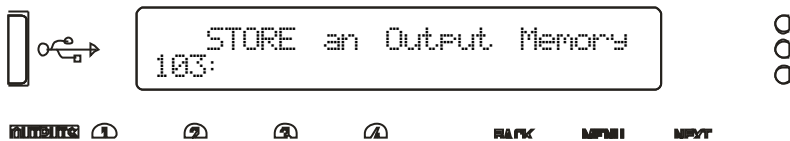

Use the encoder to choose the memory number to use – memories that are already used will show the current name and a question mark on the bottom line and ask for confirmation if chosen:

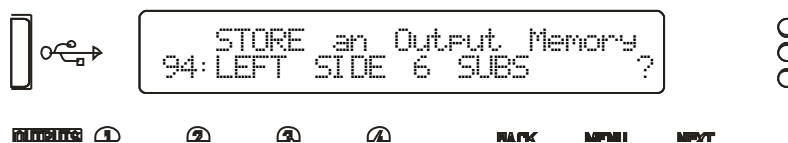

The name may now be edited/entered using a combination of the encoder and the BACK/NEXT keys to move along the name. Press ENTER when complete, or QUIT to exit.

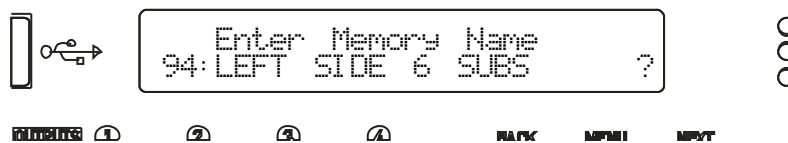

Memory is then stored, with a confirmation message and the amplifier will return to the default screen on the selected bank.

*Recalling a Memory...*

When a memory is recalled, after choosing the type (Input, Output, Source or Everything), recall of Output memories is further qualified by what bank of outputs the recalled data is to affect – amplifier or auxiliaries.

To recall a memory, from the home screen, press MENU, choose the GLOBAL MEMORY Sub-Menu and press ENTER.



Use the encoder or BACK and NEXT keys to choose either Input or Output memory type as appropriate and press ENTER.

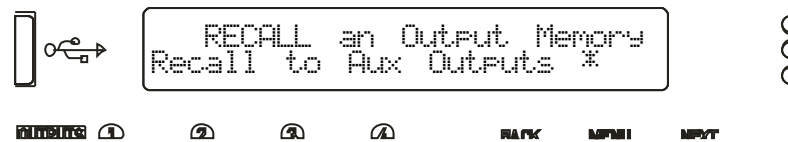

Use the encoder to choose the memory required, remembering that the list will only contain memories of the chosen type, and so the numbers may not be contiguous (so there may be gaps!)

Press ENTER and confirm. If the routing configuration of the memory just recalled is different to the current configuration, the outputs will be muted for safety.

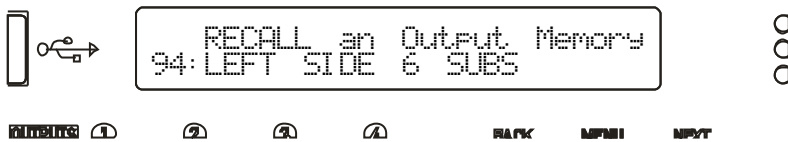

Dependant on the bank selected, the display will by default show the name of the last input, amp output or aux output memory recalled, or the same on all three if an "Everything" memory was recalled.

## Operating Your Amplifier: System Adjustments

### *Overview*

Under the System Sub-Menu you'll find all the non-audio features relating to your amplifier's operation. As these are self-explanatory, they are summarised in the table below:

<b>System Sub Menu Option</b>	<b>What it's for...</b>
System Status	Check firmware version and system information
LCD Contrast	Adjust the viewing angle for the display
LED Brightness	Adjust the brightness of meters and switch LEDs
Wakeup Time	Add a delay before start of audio fade up or keep muted
Output Meter Option	Choose if meters should show pre or post mute
Clip Hold Time	Set how long a clip or limit condition is held on meters
Filter 'Q'/Bandwidth	Show PEQ filter bandwidth as 'Q' or '1/Q' (bandwidth)
Delay Time/Distance	Choose to show delay time in metres, feet or time (mS)

## Operating Your Amplifier: Remote Control

### *Overview*

Your amplifier is equipped with multiple options for remote control. It can operate as a single device via a USB connection to the front panel, and this can also be used as a converter to an RS485 network, where other Delta devices or XTA processing units may be connected.

It may also be controlled via an Ethernet connection and again will relay data onto an RS485 network if required.

The Ethernet and USB connections can be used in an intelligent switchover mode, where the Ethernet connection is active, but will be overridden by a USB connection, allowing quick connection to a system via the front panel without needing to reconfigure the current remote interface setup.

The RS485 network can be used on its own as third means of communication, if the amplifier is part of a bigger system and an Ethernet connection is not available.

Using an Ethernet connection, multiple amplifiers can be connected directly to a standard Ethernet switch, or WiFi router, allowing for wireless communication. Connection to a WiFi router is required to control amplifier(s) with the DeltaDirect app.

Finally, the GPIO port on your amplifier can be configured to feed back a variety of alarm signals (such as over temperature threshold, or protection triggered) and offer simple closed contact control of standby mode, mutes or memory recalls. It also accepts variable voltages which allow direct level control of selected channels' gains.

### *Remote Control Software Choices*

Your amplifier is designed to be fully configured via AudioCore, our fast, intuitive software platform that works alongside the DeltaDirect app for Apple iPad devices.

Main configuration is performed via AudioCore, either with a wired connection via Ethernet, USB or RS485. Connection to amplifiers is also possible wirelessly using the Ethernet connection if this is via a wireless router.

Tuning of a system can then be performed wirelessly (via a WiFi connection) using just the iPad, which allows full adjustment of all aspects of a network of Delta DSP amplifiers.

### Configuration of the Remote Interface

To configure the remote interface, from the home screen, press MENU, choose the INTERFACE Sub-Menu and press ENTER.

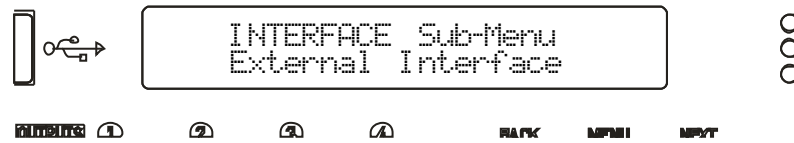

Use the encoder or BACK and NEXT keys to select External Interface and press ENTER.

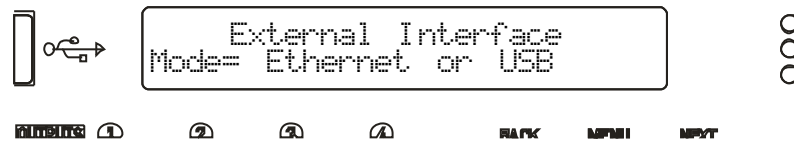

Use the encoder or BACK and NEXT keys to choose the required interface and press ENTER. This will invoke a series of further options depending on the interface chosen – these are explained below:

**Mode = OFF:** Interface is disabled and no external comms are active. This is useful if you need to fully secure your amplifier as well as locking the front panel (for more information on security and locking see page NN.)



**Mode = Ethernet Only:** The Ethernet control port on the rear panel is active. Selecting this choice will then ask for the following further information to be confirmed:

- RS485 Relay:** Choose ON to relay all remote control data onto the RS485 network for connection to further devices (other Delta DSP amplifiers or XTA processors)
- RS485 Speed:** Only shown if RS485 Relay = ON: set RS485 baud rate (recommended to use 115200 unless working with older DP224 and DP226 processors in which case use 38400)
- Remote ID Number:** Set a device ID (still required even on Ethernet connections). This must be unique to the connected unit – setting the same ID on multiple units may cause comms problems for all devices.
- IP Mode:** Choose either Static or Auto IP. Auto IP will generate an IP address based on unique hardware features such as MAC address. Choose Static if you need to select the IP address to lie within a specific range, for instance when working within a larger infrastructure.
- Gateway:** The gateway address is used for external access to the Internet and should be left at the default setting.
- Subnet:** The subnet mask is used to subdivide IP addresses into groups that allow further sub-groups addressing to be defined, so further extending the address range. Leave at default 255.255.255.0 unless specifically required.
- IP:** The IP address specifies the amplifier’s unique identifier on the Ethernet network. It is used in conjunction with the amplifier’s Remote ID number to identify individual devices on the network. Make sure this is not set to the same value as any other devices or comms problems will occur.

**Ethernet to PC**  
Connect to all units with standard CAT5 Ethernet cable to router.

This unit’s interface set as:  
Mode: Ethernet Only  
RS485 Relay: Off  
Remote ID Number: 1  
IP Mode: Auto IP

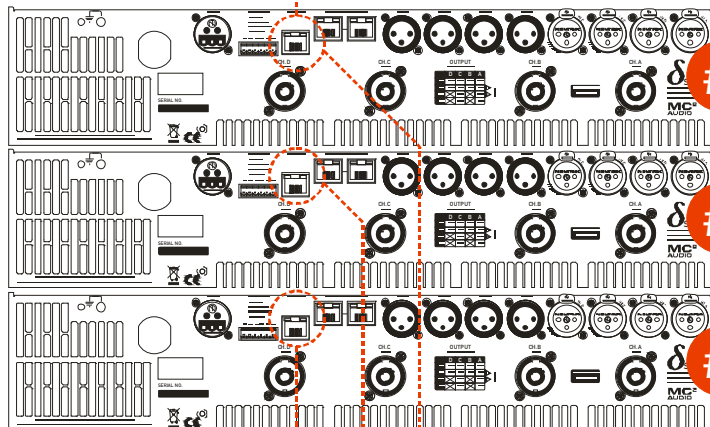

**Rear of First Unit**  
"Control" Port to Router with CAT5 Ethernet Cable

**Rear of Next Unit**  
"Control" Port to Router with CAT5 Ethernet Cable  
This unit’s interface set as for #1 EXCEPT  
Remote ID Number: 2

**Rear of Next Unit**  
"Control" Port to Router with CAT5 Ethernet Cable  
This unit’s interface set as for #1 EXCEPT  
Remote ID Number: 3



**Rear of Last Unit**  
"Control" Port to Router with CAT5 Ethernet Cable  
This unit’s interface set as for #1 EXCEPT  
Remote ID Number: N

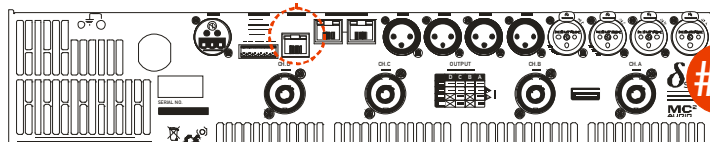

**Mode = USB Only:** The USB socket on the front panel is active. Selecting this choice will then ask for the following further information to be confirmed:

**USB Speed:** As the USB connection appears as a virtual COM port in remote software, it still has an associated serial speed. Leave at the default of 11500. This is not the actual USB serial data rate – it's the virtual COM port data rate!

**RS485 Relay:** Choose ON to relay all remote control data onto the RS485 network for connection to further devices (other Delta DSP amplifiers or XTA processors)

**RS485 Speed:** Only shown if RS485 Relay = ON: set RS485 baud rate (recommended to use 115200 unless working with older DP224 and DP226 processors in which case use 38400)

**Remote ID Number:** Set a device ID (still required even on Ethernet connections). This must be unique to the connected unit – setting the same ID on multiple units may cause comms problems for all devices.

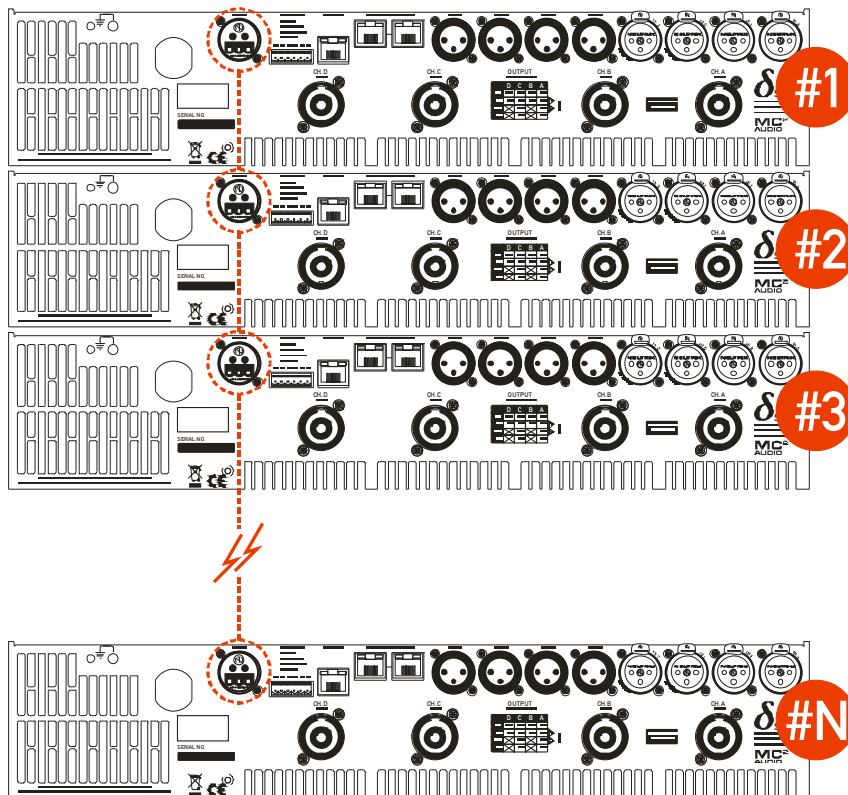
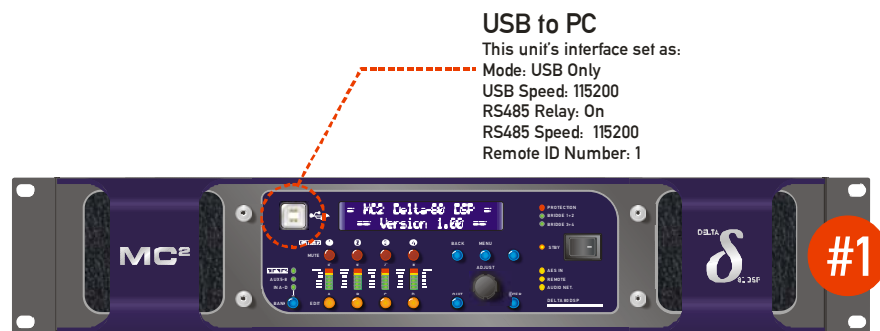

**Rear of First Unit**  
 Connect RS485 to next unit

**Rear of Next Unit**  
 Connect RS485 to next unit...  
 This unit's interface is set as  
 Mode: RS485 Only  
 RS485 Speed: 115200  
 Remote ID Number: 2

**Rear of Next Unit**  
 Connect RS485 to next unit...  
 This unit's interface is set as  
 Mode: RS485 Only  
 RS485 Speed: 115200  
 Remote ID Number: 3

**Rear of Last Unit**  
 Connect RS485 to next unit...  
 This unit's interface is set as  
 Mode: RS485 Only  
 RS485 Speed: 115200  
 Remote ID Number: N

Mode = Ethernet Or USB: The Ethernet control port on the rear panel is active, so long as the amplifier is not connected via USB, whereupon it automatically takes priority.

Selecting this choice will then ask for the following further information to be confirmed:

RS485 Relay: Choose ON to relay all remote control data onto the RS485 network for connection to further devices (other Delta DSP amplifiers or XTA processors)

USB Speed: As the USB connection appears as a virtual comm port in remote software, it still has an associated serial speed. Leave at the default of 115200. This is not the actual USB serial data rate – it's the virtual COM port data rate!

RS485 Speed: Only shown if RS485 Relay = ON: set RS485 baud rate (recommended to use 115200 unless working with older DP224 and DP226 processors in which case use 38400)

Remote ID Number: Set a device ID (still required even on Ethernet connections). This must be unique to the connected unit – setting the same ID on multiple units may cause comms problems for all devices.

IP Mode: Choose either Static or Auto IP. Auto IP will generate an IP address based on unique hardware features such as MAC address. Choose Static if you need to select the IP address to lie within a specific range, for instance when working within a larger infrastructure.

GW: The gateway address is used for external access to the Internet and should be left at the default setting.

Subnet: The subnet mask is used to subdivide IP addresses into groups that allow further sub-groups addressing to be defined, so further extending the address range. Leave at default 255.255.255.0 unless specifically required.

IP: The IP address specifies the amplifier's unique identifier on the Ethernet network. It is used in conjunction with the amplifier's Remote ID number to identify individual devices on the network. Make sure this is not set to the same value as any other devices or comms problems will occur.

**Remember that this mode is purely an automatic priority switching version of an Ethernet or USB connection – it is not possible to interconnect amplifiers via the Ethernet cables either directly or via a router – use the RS485 bus for device interconnection.**

**All three connection methods will relay data either explicitly (RS485 using the hardware bus connection) or electronically (USB or Ethernet through the processor) if required.**

**Mode = RS485 Only:** The RS485 port on the rear panel is active. Selecting this choice will then ask for the following further information to be confirmed:

**RS485 Speed:** Set RS485 baud rate (recommended to use 115200 unless working with older DP224 and DP226 processors in which case use 38400)

**Remote ID Number:** Set a device ID (still required even on Ethernet connections). This must be unique to the connected unit – setting the same ID on multiple units may cause comms problems for all devices.

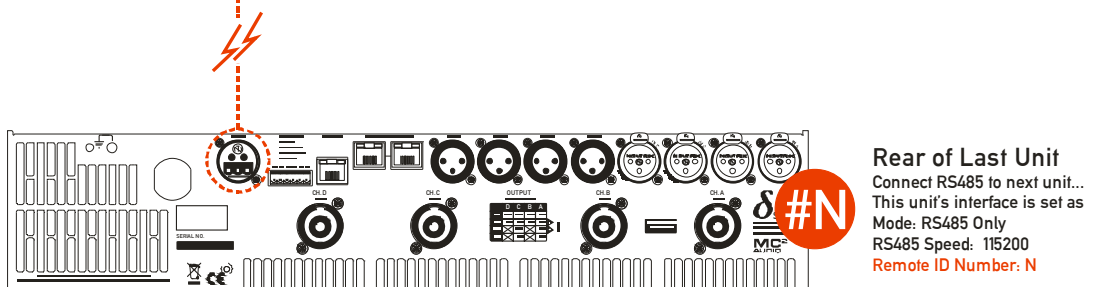
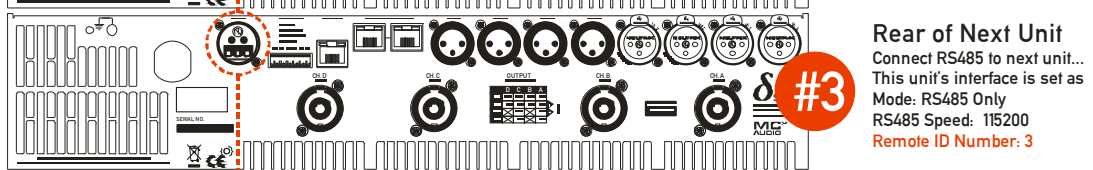
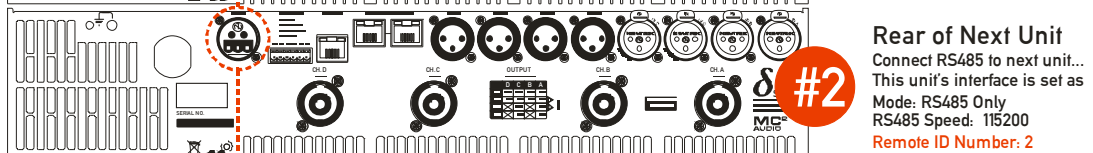
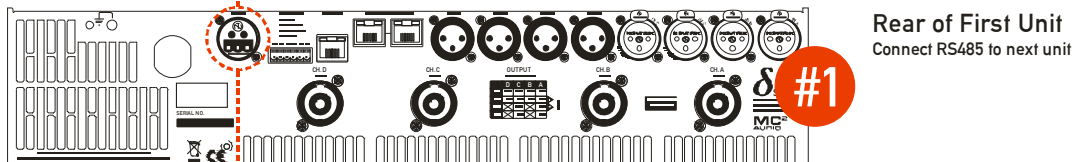
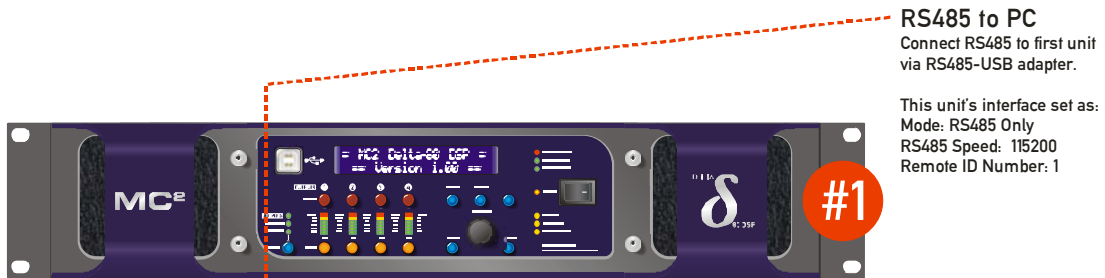

*Wireless Connection with DeltaDirect iPad App*



Free yourself of cables and go wireless! Plug the Ethernet connection from your amplifier(s) into a wireless router and you are good to go!

Main remote configuration of a single amplifier, or a network of amplifiers is performed through AudioCore, with system tuning using either AudioCore again or DeltaDirect – our elegant, intuitive app, which can be downloaded from the Apple appstore free of charge.

## Operating Your Amplifier: Resetting Back to Defaults and Clearing Security

If you need to quickly clear all current settings and memories, there are a variety of setup control codes that can do this for you.

### *Default Settings*

Your amplifier will start-up as a “four analogue inputs to four output system”, with no EQ or limiting (apart from self-protective limiters) in place. The aux outputs will “mirror” the analogue inputs (and so initially act just like “link” outputs, again with no EQ or limiting in place).

### *Entering Start-up Control Codes*

Turn the amplifier on with the BACK and ENTER keys held. The display will show:



Use the EDIT and MUTE keys to represent the characters A, B, C D for EDITS and 1, 2, 3, 4 for MUTES.

Type in one of the following codes to initiate a setup function:

D4B13D – clear **all user memories** and reset to defaults, keeping security and factory alignment settings

A2341B – clear current settings to default (leaves memories, alignments and security)

AA2121 – clear security via the XTA supplied crack code (see page NN for more information)

### Clearing Security – Forgotten Unlock Code

*Note that if you see the message “Parameters Locked!” during editing, or parameters can be viewed but not adjusted, then this is due to preset data locking or hiding and is specific to the currently running preset – this is not device security, and we cannot override it – it is specified by the speaker manufacturer.*

If you have forgotten the passcode and your amplifier is locked, you will need to contact us to unlock it after performing the following procedure. There is no master unlock code for all amplifiers – the code is generated based on an algorithm using amplifier internal settings for greater security.

Turn the amplifier on with the BACK and ENTER keys held. The display will show:

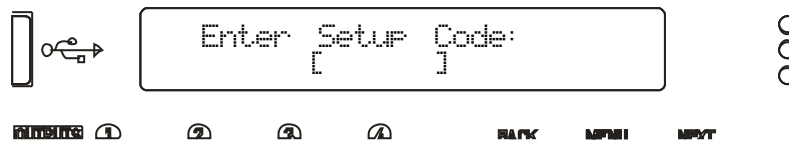

Use the EDIT and MUTE keys to represent the characters A, B, C D for EDITs and 1, 2, 3, 4 for MUTEs.

Type in AA2121.

The display will now show:

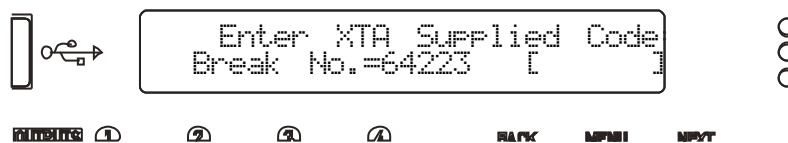

Make a note of the “Break Number” shown (64223 in this example) and contact us with this – we can then supply the code to unlock your amplifier.

Do not enter any menus or make any further adjustments to the amplifier or this code may “roll over” and you will need to go through this procedure again. Either switch the amplifier off or press QUIT to exit without entering a code.

Resetting security leaves does not delete any settings – it just clears the locking passcode.

## Looking After Your Amplifier: Maintenance

These maintenance instructions are for use by qualified personnel only. Before any routine maintenance, please ensure that your amplifier is disconnected from the mains supply!

The filter behind the air intake apertures on the front of your amplifier should be cleaned or replaced periodically, e.g. 3 -6 months. (Filters in amplifiers located in more 'dirty' atmospheres may require more frequent maintenance).

The filter should be 'dry' cleaned, using a vacuum cleaner preferably. Running the unit without a filter is not recommended. We recommend replacement of filters every 2-3 years, depending on usage. Replacement filter material is available directly from us.

If the fan vents on the rear of the amplifier develop a build-up of dust/debris on the finger guards, they can be cleaned with a dry paintbrush and a vacuum cleaner.

The casework of the amplifier may be cleaned with a lightly dampened cloth – do not use any solvents as they will damage the paint finish and could remove printing.

If you have any doubts about carrying out maintenance, please refer to a service engineer or contact your local dealer.

## Looking After Your Amplifier: Warranty

Your amplifier is guaranteed for a period of five (5) years from the date of manufacture. Please note that this does not apply to OEM versions of the amplifier – please consult your manufacturer for their warranty terms. We hope that it gives you many more years of reliable service than this, but should anything go wrong, please contact us to advise you about repairs or any spares you might require.

Please do not attempt to repair the amplifier yourself as doing so will invalidate the warranty.

Our contact details are:

MC<sup>2</sup> Audio,  
Units 6-8 Kingsgate  
Heathpark Industrial Estate  
Honiton, Devon  
England  
EX14 1YG

Tel: +44(0)1404 44633

Fax: +44(0)1404 44660

email: [sales@mc2-audio.co.uk](mailto:sales@mc2-audio.co.uk) for general enquiries

Our website is a great place to get started if you have any questions regarding the general use of your amplifier or need copies of this manual in digital form, or datasheets and photographs. The datasheets also contain architect's and engineer's specifications.

[www.mc2-audio.co.uk](http://www.mc2-audio.co.uk)



## Performance Of Your Amplifier: Specifications

## Main Specifications

Parameter (Units)	Delta 80 DSP	Delta 100 DSP
Output Power per channel [Crest Factor = 4.8] (Watts)		
8 Ohms	1000	1400
4 Ohms	2000	2700
2.7 Ohms	2200	3700
2 Ohms	2000	3500
Output Power per channel bridged [Crest Factor = 4.8] (Watts)		
8 Ohms	4000	5600
4 Ohms	4000	7000
THD+N, 4 Ohms (%)		
@1kHz, 1dB below max output power <	0.18	0.08
@20Hz - 20kHz, 1dB below max output power <	0.2	0.1
Gain Options (dB)	32	32
Sensitivity Options for max power (dBu)	8.3	10.7
Sensitivity Options for max power (Volts)	2.0	2.66
Frequency Response, +0/0.5dB (Hz)	20 – 20000	20 – 20000
Power Consumption, Nominal @ 240V, 4 Ohms (A)	5.0	7.5
Power Consumption, Nominal @ 120V, 4 Ohms (A)	10.4	15.5
Dimensions H x W x D (mm)		
Amplifier	88 x 482 x 428	88 x 482 x 428
Boxed	230 x 580 x 560	230 x 580 x 560
Boxed Shipping – all except UK	250 x 610 x 600	250 x 610 x 600
Weight (kgs)		
Amplifier	10.3	10.9
Boxed – shipping	11.8	12.4

## Additional Specifications

Parameter (Units)	Delta 80 DSP	Delta 100 DSP
Input Impedance – Active Balanced (Ohms)	20k	20k
Input CMRR (dB)	> 60	> 60
Damping Factor, 1kHz, 8 ohms	> 400	> 400
Signal Limiters Present	Yes	Yes
Protection Present – Short Circuit / DC Output / Temperature	Yes	Yes
Mains In-rush Control Present	Yes	Yes
Output Power per channel, 8 Ohms (Watts)		
Continuous music [Crest Factor of 2.8 or 9dB]	975	1360
Continuous music [Crest Factor of 4.8 or 14dB]	1000	1400
Continuous music [Crest Factor of 7.8 or 18dB]	1025	1440
Output Power per channel, 4 Ohms (Watts)		
Continuous music [Crest Factor of 2.8 or 9dB]	1950	2620
Continuous music [Crest Factor of 4.8 or 14dB]	2000	2700
Continuous music [Crest Factor of 7.8 or 18dB]	2050	2780
Output Power per channel, 2.7 Ohms (Watts)		
Continuous music with Crest Factor of 2.8 [9dB]	1960	3600
Continuous music with Crest Factor of 4.8 [14dB]	2010	3700
Continuous music with Crest Factor of 7.8 [18dB]	2060	3880

Due to continuing product improvement, the above specifications are subject to change.

## Power Consumption and Thermal Emissions – Delta 80DSP

Mains (V)	Load (R)	Current Draw (A)				Thermal Emissions (W)			
		No Sig'l	Light	Average	Heavy	No Sig'l	Light	Average	Heavy
<b>240</b>	<b>8</b>	1.5	2.2	3.4	6.3	360	378	410	486
<b>240</b>	<b>4</b>	1.5	2.8	5.0	10.3	360	394	453	593
<b>240</b>	<b>2</b>	1.5	3.1	5.8	12.4	360	402	474	647
<b>120</b>	<b>8</b>	3.3	4.7	7.1	12.9	400	418	450	526
<b>120</b>	<b>4</b>	3.3	5.9	10.4	21.0	400	434	493	633
<b>120</b>	<b>2</b>	3.3	6.5	12.0	25.1	400	442	514	687

## Power Consumption and Thermal Emissions – Delta 100DSP

Mains (V)	Load (R)	Current Draw (A)				Thermal Emissions (W)			
		No Sig'l	Light	Average	Heavy	No Sig'l	Light	Average	Heavy
<b>240</b>	<b>8</b>	2.1	3.2	5.1	9.6	504	533	582	701
<b>240</b>	<b>4</b>	2.1	4.1	7.5	15.7	504	557	647	863
<b>240</b>	<b>2</b>	2.1	4.6	8.9	19.1	504	570	682	953
<b>120</b>	<b>8</b>	4.7	6.9	10.6	19.6	560	589	638	757
<b>120</b>	<b>4</b>	4.7	8.7	15.5	31.9	560	613	703	919
<b>120</b>	<b>2</b>	4.7	9.7	18.2	38.7	560	626	738	1009

No Sig'l = Quiescent, Light = Crest Factor of 7.8(18dB),

Average = Crest Factor of 4.8(14dB), Heavy = Crest Factor of 2.8(9dB)

For details of measurement methods please refer to the Technical Support area of our website.

## Auxiliary Outputs and DSP Performance

Parameter (Units)	Delta 80 DSP / 100 DSP
Source Impedance – Active Balanced (Ohms)	< 60
Minimum Load (Ohms)	600
Maximum Output Level (dBu)	+18
ADC, DAC and DSP sample rate (kHz)	96
AES accepted sample rates (kHz)	32-192
Dynamic Range (20Hz-20kHz Unwtd, dB)	>114
Distortion (@1kHz, +10dBm, %)	<0.001
<b>Signal Processing</b>	
Delay up to 650mS (inputs), 650ms(outputs) – independant	
Filters Parametrics – 8 Per input / 9 per output Each parametric can be switched to Bandpass, Allpass, Notch, VariQ, Shelf and Elliptical response Phase filtering – 2 degree steps on each input and output	
FIR Filtering – available on all outputs – total maximum taps available: 4000*	
Crossover Filters (per output) Bessel / Butterworth 6/12/18/24/48dB per octave and Linkwitz-Riley 12/24/48dB per octave	
Dynamic EQ** 3 bands (per input) Parametric behaviour – 19.7Hz – 32kHz 'Q' 0.4 – 128, Max gain automatic gain adjustment 18dB Max ratio (cut above mode) 4:1 Max ratio (all other modes) 2:1 Attack 70uS – 2.0 Seconds Release 11mS – 3.4 Seconds	
Mix matrix mode (auxes and amplifier outputs) Input sends to each output continuously variable from -40.0dB to _15.0dB in 0.1dB steps plus mute	
Limiter Threshold +18dBu to -12dBu (auxiliary outputs); +42dBu to +20dBu (amplifier outputs) Attack time 0.1 to 91 milliseconds Release time 2, 4, 8, 16 or 32 times the attack time	
Clip/D-max Limiter Look-ahead attack time, Fast, Medium or Slow release times	
*FIR Filtering enabled in later firmware release – 4000 taps with DEQ globally disabled	
** DEQ enabled in later firmware release	

## Appendix I: Limiters and How to Set Them Correctly

Your amplifier has two levels of dynamic protection on its outputs – a traditional program limiter, and a peak limiter.

### *Program Limiter*

High performance digital limiters are provided for each output with control over attack time, release time and threshold parameters. This level of control allows the user to balance the required subjective quality of the limiter against the driver protection requirements. It does also mean that an incorrectly set limiter may sound awful!

In particular (as with all limiters) using too fast an attack or release time for the type of signal in the pass-band will result in excessive low frequency distortion. There is provision, within the remote software application, to set automatic limiter time constants. Use this option if you are unsure how to set the time constants manually. We recommend the use of the automatic setting.

In this mode the time constants will be automatically set from the corresponding channel's High-Pass filter frequency according to the table below.

High Pass Filter	Auto Attack Time	Release Time
<10Hz – 31Hz	45mS	x16 (720mS)
31Hz – 63Hz	16mS	x16 (256mS)
63Hz – 125Hz	8mS	x16 (128mS)
125Hz – 250Hz	4mS	x16 (64mS)
250Hz – 500Hz	2mS	x16 (32mS)
500Hz – 1kHz	1mS	x16 (16mS)
1kHz – 2kHz	0.5mS	x16 (8mS)
2kHz – >32kHz	0.3mS	x16 (4mS)

### Peak Limiter

The main limitation with traditional dynamics control is the inability of the processing to react truly instantaneously to the signal. One of the most significant advantages of digital signal processing over analogue is the ability to delay the audio signal precisely and without extensive complex hardware. The entire domain of digital signal processing is based around the combination of delaying, multiplying, and accumulating numbers (representing samples of audio) to implement all the filters and dynamics processing we have come to expect today.

In the case of dynamics processing, being able to delay a signal allows the processor module to delay the main signal in relation to the sidechain (the signal being monitored relative to the threshold), so that it can compensate for peaks prior to the arrival of the main signal.

Consider the situation of a monitor engineer listening to a band perform. Having no access to dynamics processors, he has had to resort to manually 'riding the faders' in an attempt to keep control of the levels. Should the level of one of the channels on his desk reach an unacceptably high level, he will turn it down appropriately.

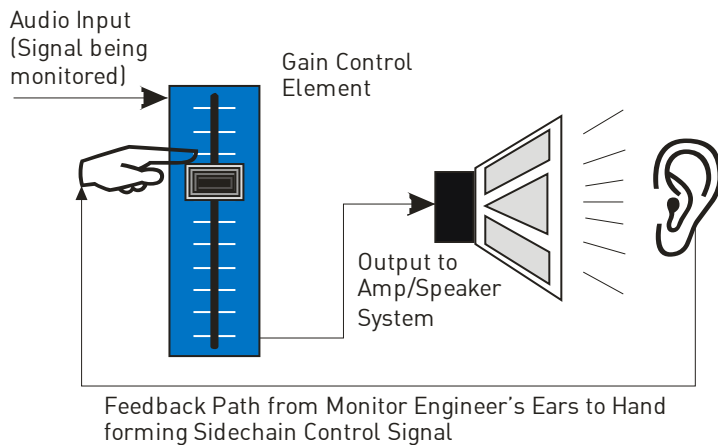

There is a hidden sidechain in operation even in this case. The main signal path is fed through the monitor desk and the gain controlled by adjusting the fader. The sidechain is formed by the feedback path between the engineer's ears checking the level and his brain instructing his hand to turn the fader down if the volume goes over the threshold he has chosen.

In this case, the delay between the signal actually going over the threshold, the engineer registering the situation, and then turning the signal down will be in the order of several hundred milliseconds at best. This will only be true if he is not distracted – in reality, it may be several seconds before any gain reduction is imposed on the signal to bring it under control.

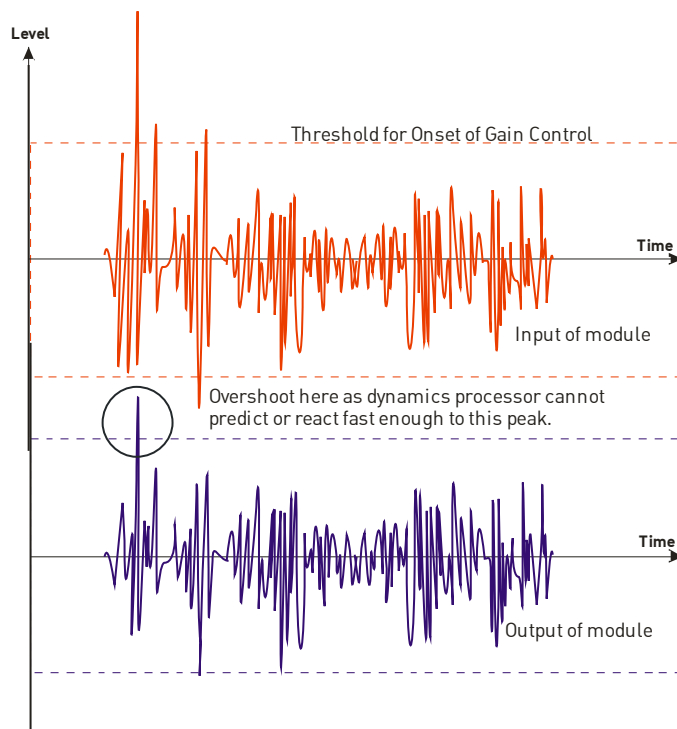

For an analogue dynamics processor, the situation is much better. Controlling the gain electronically, and not relying on a human sidechain feedback mechanism, it can react much more quickly.

The red waveform represents the input to the dynamics module, with the dotted line showing the threshold for gain control to occur. There are several peaks towards the start of this signal that are above the threshold, and so the dynamics processing should react to these as appropriate. (In this case reduce the gain).

The blue waveform shows the output of the dynamics module.

The circled peak demonstrates that the processor has missed the first peak above the threshold (as it is very fast and short), but has 'caught up' shortly afterwards, keeping all other peaks under control. As it is unable to predict what is coming, this will always be a failing with analogue dynamics processing.

The peak limiter pre-delays the sidechain signal, resulting in a "zero overshoot" limiter, which is able to catch all peaks and provide a reliable absolute maximum setting for the output of any channel.

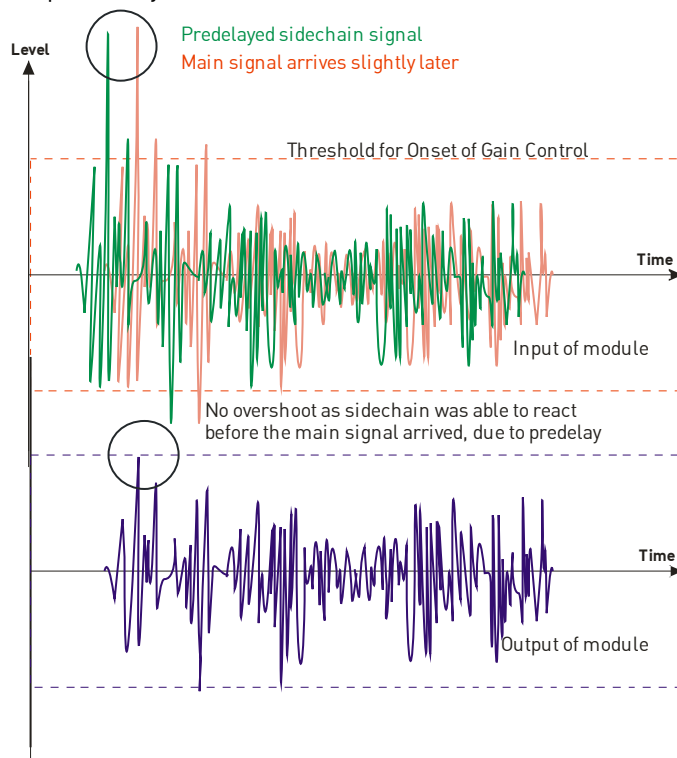

The pre-delayed sidechain is shown in green, with the main signal in red. As the main signal arrives slightly after the sidechain, the output from the unit does not suffer from the overshoot problem.

Remember that this delay is only in the order of tens of microseconds, and is a **pre-delay** – the sidechain is moved **back** in time in relation to the main signal. Inserting a delay into the **main** signal path of an analogue dynamics processor will achieve similar results, but with the penalty of delaying the main signal by the amount of look ahead delay introduced.

The peak limiter follows the RMS limiter, has only two parameters to adjust – the release time and the threshold. Note that the threshold is set to be a minimum of 2dB above the threshold of the program limiter – setting the threshold to “10dB above” means that no more than 10dB of overshoot above the threshold of the program limiter will ever be allowed. The release time can also be automatically set if the RMS limiter has automatic time constants enabled and so are set by the high pass filter frequency for that channel.

### *Setting Accurate Limiter Thresholds – Program Limiter*

#### Introduction

The limiters built into your amplifier are intended to be used for loudspeaker driver protection, as opposed to amplifier protection. The amplifier has additional limiters which can adapt automatically to both temperature and incoming mains conditions to stay operational and playing music for as long as possible. The following section describes how to set up the units' limiters to provide exceptional protection against driver overheating and cone over-exursion. Most speaker systems are given a power rating in Watts RMS. This is the maximum continuous power that the system will handle and often appears very conservative. In reality, as music program is far from continuous in nature, the peak power of the system is much higher – up to ten times the continuous figure. Any limiter, which is to protect the driver from damage, must be able to fulfil the following tasks:

- Have an attack time which is calculated to allow transients through but keep the RMS level below the speaker manufacturers specification;
- Have a release time which is sufficiently long to avoid the limiter itself modulating the program;
- Be intelligent enough to adjust the envelope of the limiter according to the frequency content of the program material.

The RMS limiters are capable of performing all these tasks. The only parameter that the user must set manually is the threshold, and it is crucial that this is done correctly.



*Amplifier Outputs' Program Limiter Lookup Table*

**Note that the setting of the auxiliary outputs' limiters need to be referenced to the external amplifier's gain for correct operation. A separate lookup table and explanation is given overleaf.**

Consider the table below.

dB Limit	Power 8Ω	Power 4Ω	Power 2.7Ω <sup>2</sup>	Power 2Ω
48	4721	9442	Bridge Mode Operation Not Possible	
47	3753	7506		
46	2982	5964		
45	2370	4741		
44	1884	3768		
43	1496	2993		
42	1189	2377	3396	4755
41	944	1888	2698	3777
40	750	1500	2143	3000
39	596	1192	1702	2383
38	473	946	1352	1893
37	376	752	1074	1504
36	299	598	853	1194
35	237	474	678	949
34	188	377	538	754
33	150	299	428	599
32	119	238	340	475
31	94	189	270	378
30	75	150	214	300
29	60	120	178	240
28	47	94	139	188
27	38	76	113	152
26	30	60	89	120
25	24	48	71	96
24	19	38	56	76
23	15	30	44	60
22	12	24	36	48
21	10	20	30	40
20	7.50	15	22	30

First, check the RMS power rating of the speaker system, and its impedance. Look up this value in the table above, using the closest value **below** the rated power of the speaker system. Note the corresponding 'dB' value. Note that, for safety, always set the limiter threshold 1 or 2 dB below the maximum allowable worked out using the above method.

The section in grey will only be relevant when pairs of output channels are bridged. Under these conditions, the available limiter threshold range will increase by 6dB to +48dB.

The minimum impedance for bridged channels is 4R, so this section of the table is left intentionally blank. Driving the amplifier into loads lower than those recommended will result in the channels muting and may result in damage to the affected channels.

<sup>2</sup> 2.7Ω is the ideal subwoofer load of 3 x 8Ω drivers in parallel for most efficient power delivery

*Auxiliary Outputs' Program Limiter Lookup Table*

**Note that the setting of the amplifier outputs' limiters does not need to be referenced to the amplifier's gain as this is predetermined for the internal power amplifier sections. A separate lookup table and explanation is given on the previous page.**

Consider the table below.

dB	Ratio	Vrms	Pwr 8Ω	Pwr 4Ω	Pwr 2.7Ω	Pwr 2Ω
45	177.83	137.74	2371.71	4743.42	7027.28	9486.83
44	158.49	122.77	1883.91	3767.83	5881.95	7535.66
43	141.25	109.41	1496.45	2992.89	4433.92	5985.79
42	125.89	97.52	1188.67	2377.34	3512.98	4754.68
41	112.20	86.91	944.19	1888.39	2796.60	3776.78
40	100.00	77.46	750.00	1500.00	2222.22	3000.00
39	89.13	69.04	595.75	1191.49	1765.18	2382.98
38	79.43	61.53	473.22	946.44	1042.13	1892.87
37	70.79	54.84	375.89	751.78	1113.75	1503.56
36	63.10	48.87	298.58	597.16	884.68	1194.32
35	56.23	43.56	237.17	474.34	702.43	948.68
34	50.12	38.82	188.39	376.78	556.19	753.57
33	44.67	34.60	149.64	299.29	443.38	598.58
32	39.81	30.84	118.87	237.73	352.21	475.47
31	35.48	27.48	94.42	188.84	279.76	377.68
30	31.62	24.49	75.00	150.00	222.22	300.00

Using this table it is a straightforward procedure to work out the required setting of the limiter thresholds for the system.

First, check the RMS power rating of the speaker system, and its impedance.

Look up this value in the table above, using the closest value below the rated power of the speaker system. Note the corresponding 'dB' value.

Check the gain of your amplifier, which needs to be in 'dB'.

Subtract this gain figure FROM that obtained from the table to find the required absolute setting for the limiter thresholds.

Note that, for safety, always set the limiter threshold 1 or 2 dB below the maximum allowable worked out using the above method.

As an example, for a subwoofer rated at 2000W and 4R, working with an amplifier which has 32dB of gain, the limiter threshold would be calculated as follows:

"First, check the RMS power rating of the speaker system, and its impedance." **2000W, 4R**

"Look up this value in the table above, using the closest value below the rated power of the speaker system. Note the corresponding 'dB' value." **41dB**

"Check the gain of your amplifier, which needs to be in 'dB'." **32dB**

"Subtract this gain figure FROM that obtained from the table to find the required absolute setting for the limiter thresholds." **41 - 32 = +9dB**

"Note that, for safety, always set the limiter threshold 1 or 2 dB below the maximum allowable worked out using the above method." **with safety, +8dB**

### *Setting Accurate Limiter Thresholds – Peak Limiter*

Assuming the RMS limiter has been set correctly and, just as importantly, attack and release times have been chosen as appropriate to the driver to be protected, the peak limiter is typically set to limit overshoot to 3dB above the RMS limiter threshold.

This would allow peaks of twice the RMS power level to reach the outputs. If the driver has a peak power capability of more than double the rated RSM power, then this value can be increased.

To calculate the setting for the peak limiter it's:

$$10 \times (\text{Log}^{10}(\text{Peak\_Power} / \text{RMS Power}))$$

So for example, a 15" driver has a quoted RMS power handling of 800W, and a peak power handling of 1600W, the calculation is

$$\begin{aligned} (1600/800) &= 2 \\ \text{Then } \text{Log}^{10}(2) &= 0.3010 \\ \text{Then } 10 \times 0.3010 &= 3.010 \text{ or } 3\text{dB} \end{aligned}$$

Speaker manufacturers may quote AES power in place of RMS power and "Program" instead of "Peak". These terms, whilst not strictly interchangeable, are similar as a "pair" of measurements. AES tends to be a slightly more conservative rating given the definition of how it is measured.

If AES power is quoted, then it normally is paired with the "Program" rating and so the calculation of the threshold for the peak limiter is still valid.

### *Setting Appropriate Attack and Release Times*

As stated earlier in this appendix, having control over the attack and release times of the program limiters allows the user to balance the required subjective quality of the limiter against the driver protection requirements. It does also mean that an incorrectly set limiter may sound awful!

In particular (as with all limiters) using too fast an attack or release time will result in excessive low frequency distortion. When setting limiter attack and release times during the crossover configuration there is an option for automatic limiter time constants. Use this option if you are unsure how to set the time constants manually. See page 37 for details on how to turn this option on.

We recommend the use of the automatic setting.

In this mode the time constants will be automatically set from the high pass crossover filter frequency according to the table below:

High Pass Filter	Auto Attack Time	Auto Release Time
<10Hz – 31Hz	45mS	x16 (720mS)
31Hz – 63Hz	16mS	x16 (256mS)
63Hz – 125Hz	8mS	x16 (128mS)
125Hz – 250Hz	4mS	x16 (64mS)
250Hz – 500Hz	2mS	x16 (32mS)
500Hz – 1kHz	1mS	x16 (16mS)
1kHz – 2kHz	0.5mS	x16 (8mS)
2kHz – 32kHz	0.3mS	x16 (4mS)

Only the release time may be adjusted for the peak limiters, as attack time is always set to “zero-overshoot” and so cannot be changed. The release time may be set to “slow”, “medium” or “fast” – we recommend using the automatic setting which is selected for both limiters at the same time as part of the crossover configuration, detailed on page 37.

## Appendix II: Upgrading Firmware and Loading Presets

Loading new firmware or presets uses the same “Flash Loader” utility that is bundled with the firmware or presets “bin” (binary) file. Firmware (or Program) files have the prefix “LTAM”, and preset files have the prefix “LTAR”.

### *Amplifier Communications Set-up*

Updates can be performed through an Ethernet, US or RS485 connection. Choose the correct port on the amplifier and configure it accordingly through the Interface Sub-menu. See page 46 for more info on choosing the interface.

### *Download the Files*

Go to the Support > TechNotes section of the MC2 website to find the latest firmware or presets – these will be bundled with the “Flash Loader” application that is used to connect and update your amplifier.

<http://www.mc2-audio.co.uk/support/tech-notes/>

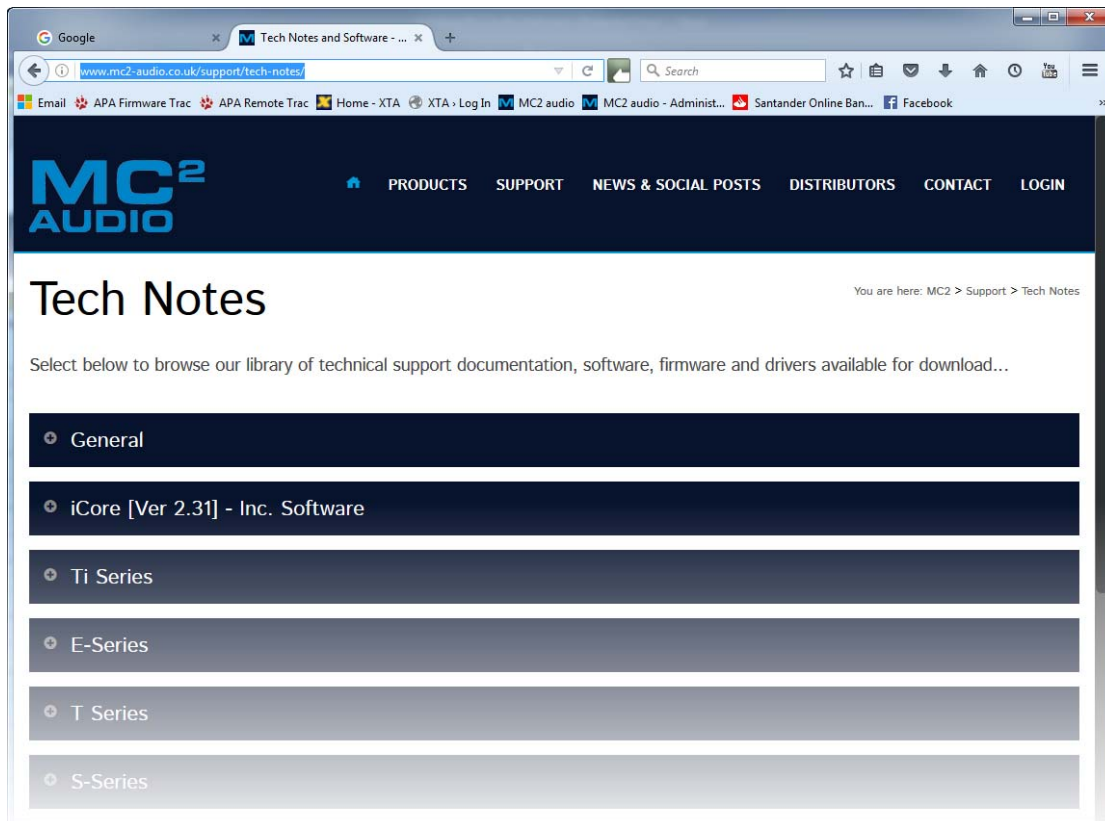

Unzip the files – you will have the loader application, and the firmware or preset file as appropriate.

### Connect To The Amplifier

Plug in the appropriate cable according to your chosen connection method. Remember – if you are connecting via an USB or RS485, you will need to make sure your amplifier is set to ID1 for the loader to find it.

Start the loader application:

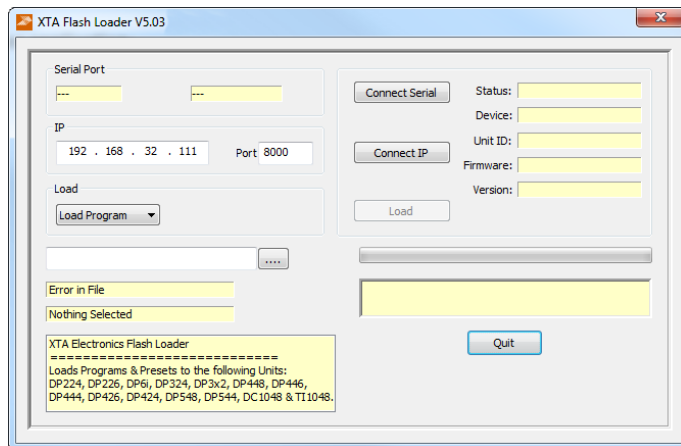

Press the “Connect Serial” button if using USB or RS485, or “Connect IP” if using an Ethernet connection. **We recommend you choose either a USB or wired Ethernet connection.**

After a few seconds, the unit should be located and its status and type should be displayed, along with the current firmware and some other information.

### Choose What To Load

From the drop-down list under “Load” choose either “presets” or “program” (firmware), and then locate the correct file by pressing the “...” button.

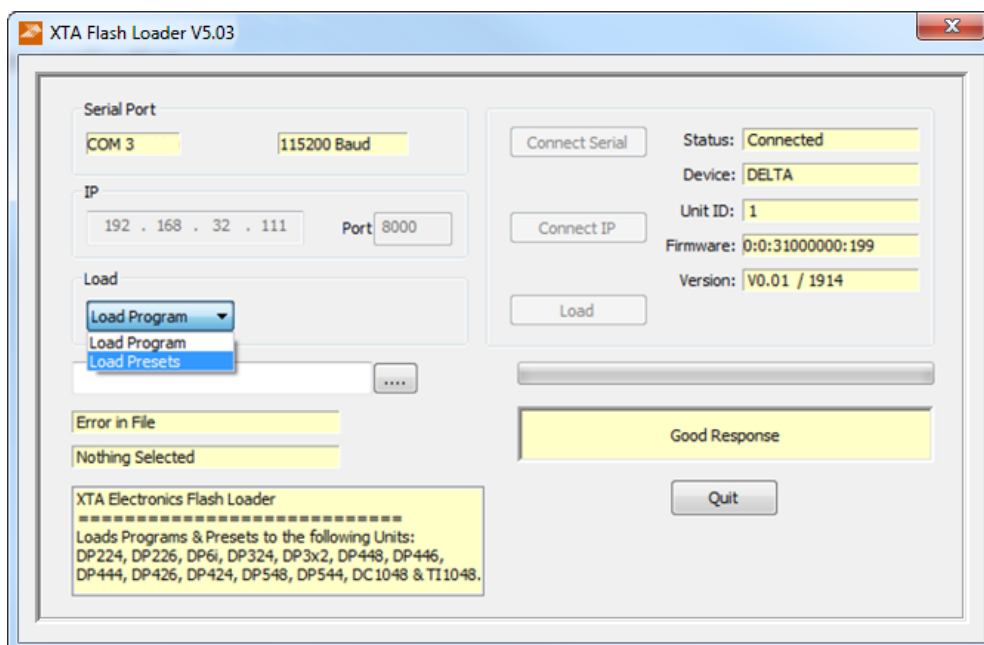

The file type will have been filtered for you – LTAM\*.bin for firmware (program) files or LTAR\*.bin for preset files.

*Start The Update!*

Just before you press the “Load” button – please close any other applications running on the PC – interruptions in the process could render your amplifier inoperable. Do not disconnect the cable, turn off the power or attempt to close the loader app once loading has begun!

Now that you have been warned (!) – press the “Load” button. Confirm the load, and the amplifier will switch to Standby and begin to load the new firmware. A message detailing progress will accompany the bar on the loader app:

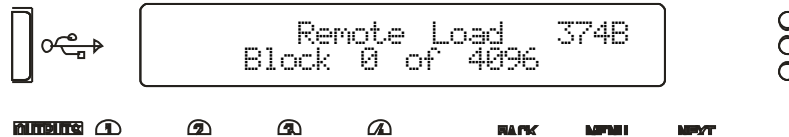

Upon completion, the app will close and your amplifier will restart – that’s it!

*What If It All Goes Wrong...*

Don’t panic! Your amplifier can be recovered, but please be aware that...

**THE AMPLIFIER OPERATES AT VOLTAGES IN EXCESS OF THE INCOMING MAINS VOLTAGE, AND THESE VOLTAGES REMAIN PRESENT FOR AN EXTENDED PERIOD AFTER MAINS POWER IS REMOVED!**

**READ THESE INSTRUCTIONS CAREFULLY AND HEED ALL WARNINGS!**

Disconnect your amplifier completely from the incoming mains supply.

Ensure that the HT present LEDs visible here through the front left vent with the foam removed...

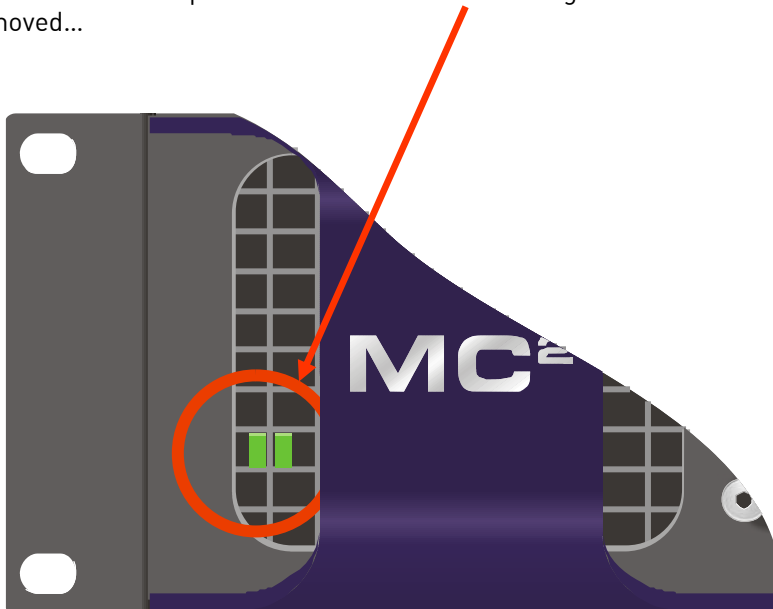

...are fully extinguished before continuing. This will take **at least five minutes** so please be patient for your own safety.

It is now safe to remove the top cover of your amplifier – there are four screws (Torx) along each side and eight on the top of the cover. Be careful not to drop any screws inside!

Locate the “Rescue Recovery” link CN11 – between ICs U24 and U28 on the top circuit board - and remove it. This will make your amplifier run in recovery mode – the original firmware version loaded at the factory will now be active.

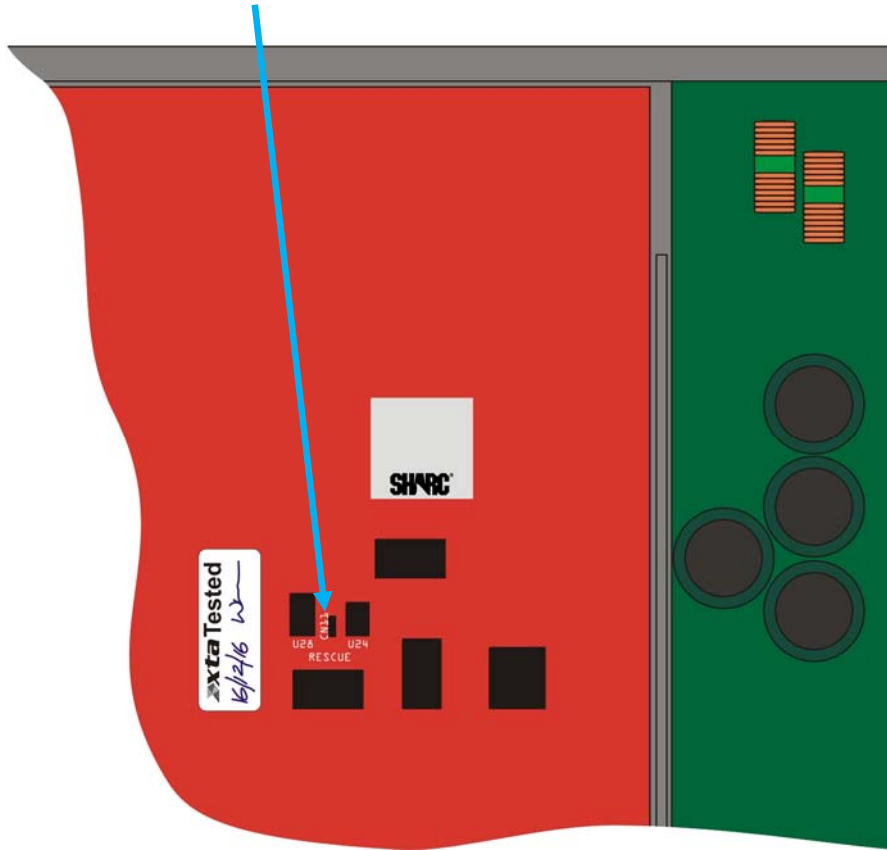

Replace the top cover temporarily, reapply mains power and switch on. Once booted, check the interface is set as required and perform a program update again using the Flash Loader application.

The display will show an additional “R” next to the Remote Load message to show rescue mode is active:

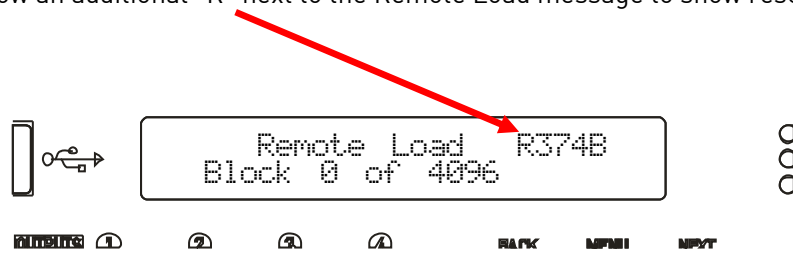

Upon completion, the app will close. Disconnect the power and wait for at least five minutes until the HT Present LEDs have fully extinguished again.

Remove top cover and replace the “Rescue Recovery” link once more. Replace top cover and screw down, and replace the filter foam in the left hand front vent.

Your amplifier should now be fully operational again – no settings will have been lost in the process.